

Soft Ice Cream Maker User Manual

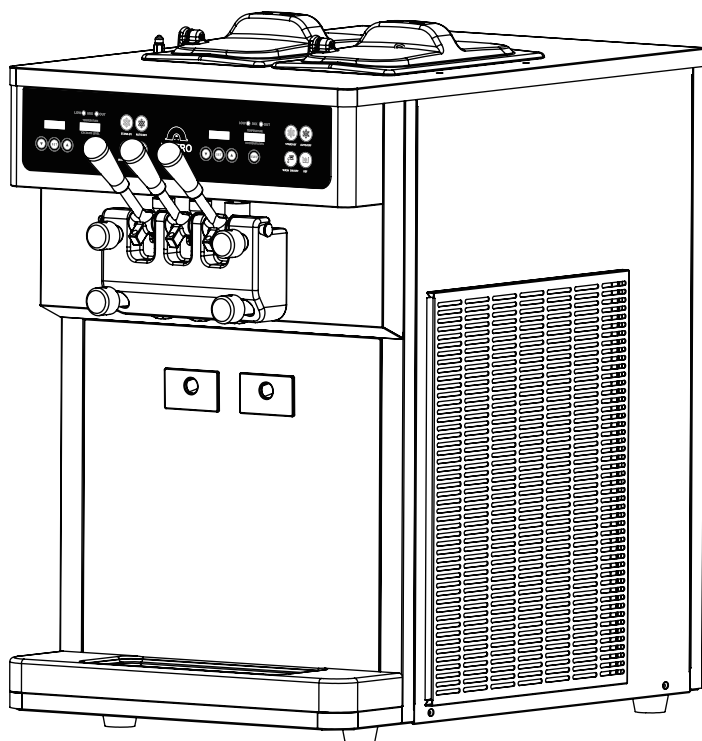

ISI-163TT

- Read this manual carefully before using the product.
Keep the booklet in a safe place after reading.
- The product is to be used indoors.
Be sure to install it inside a building.
- Appearances, design, color, or parts may be changed
without prior notice for the most effective manufacturing process.

This Soft Ice Cream Maker has the following benefits:



1. Minimum noise and refreshing cooling system

With a high efficiency and low noise motor, we can achieve minimal noise from the refreshing cooling system

2. MICOM control method

Use of an artificial intelligence control type achieves an optimal cooling system.

3. Body sensing button

The touch button provides a smoother operation.

4. Adopted agitator

Refrigerating temperature is being kept stable by adopting an agitator.

5. Independent cooling system

Separate systems are used for freezing and storage to give more convenience.

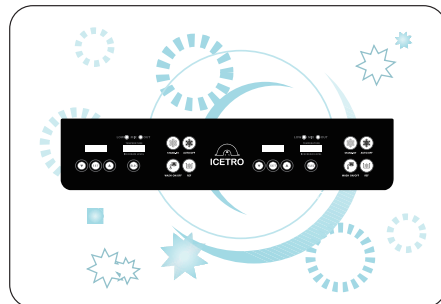
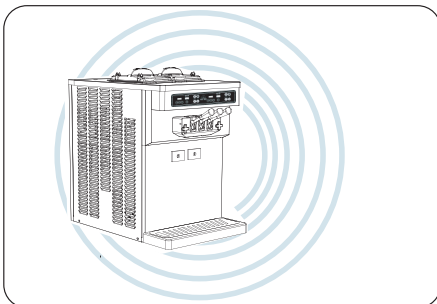

Dear customers;

Thank you very much for purchasing a soft ice cream maker made by ICETRO. For correct use of the product and its maintenance, please read this manual carefully. If a problem occurs while using the product, you can refer to this manual for troubleshooting. This manual contains a product warranty, so keep it safely for future reference. This product can be installed only by someone qualified for installation. If use of parts and accessories not provided or approved by ICETRO or any part or accessories made by ICETRO but remodeled by other person causes a problem, we are not responsible for it financially. (The functions and specifications shown in this manual and on the web site are subject to change without notice. Please visit our website at <http://www.icetro.com> to obtain the latest specifications.

Contents

Acknowledgment

Cautions for your safety	04~06
– Power supply related items	04
– Installation related items	05
– During use	05~06
Part names and controller	07~08

Method of Use

Check prior to use	09
Button display description and functions	10
Functional description of the buttons	11~13
How to make soft ice cream	14
How to adjust the carburetor	15

Cleaning Method

Cleaning Method	16~18
– Wash mode	16~17
– Washing of each parts	18
– Condenser and filter cleaning method	18
– Drain slug cleaning method	18

ETC

Dasher cover assembly method	19~20
–Dasher assembly	19
–Dasher cover assembly	20
Installation method	21
Before requesting service	22
Error code types	23
Circuit diagram	24
Service for Refrigerant Lines	25~27
Removal and Replacement of Compressor	28
Removal and Replacement of Capillary Tube	29
Removal and Replacement of Condenser ¹	30
Replacement of Fan motor	31
Refrigerant circuit	32
Product specification	33
Part list	34~37
What to watch out for	38
Warranty	39

Cautions for your safety

These are safety related items. So, comply with them at all times!

They are meant to protect the safety of users and prevent property damages. Please, read the cautionary items carefully for correct use.



If violated, it can cause death or severe injury.



If violated, it can cause severe physical injury or property damages.



If violated, it can cause slight physical injury or property damages.

Power supply related items

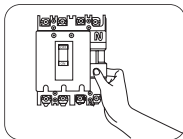

- ⚠ Install it independently with an earth leakage circuit breaker with more than 20~50[A].
It can cause electrical shocks or fire.

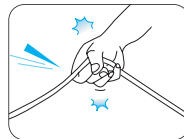

- ⚠ Do not pull on the power cord.
It can cause electrical shocks or fires.

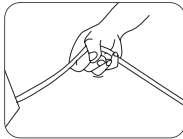

- ⚠ Do not move the product by pulling on the power cord.
It can cause electrical shocks or fires.

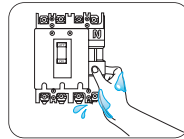

- ⚠ Do not touch the earth leakage circuit breaker with your wet hands.
It can cause electrical shocks or fires.

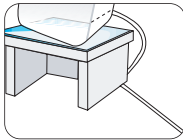

- ⚠ Do not bend the power cord too much or cause damages or deformation by pressing it under a heavy object.
It can cause electrical shocks or fires.

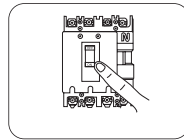

- ⚠ Do not turn the power on/off with the circuit breaker continuously.
It can cause electrical shocks or fires.

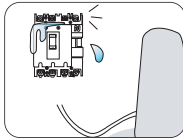

- ⚠ If there is water inside the an earth leakage circuit breaker turn off the earth leakage circuit breaker and dry it before use.
It can cause electrical shocks or fires.



- ⚠ When you repair or inspect the product or replace any parts, turn off the earth leakage circuit breaker.
It can cause electrical shocks or fires.

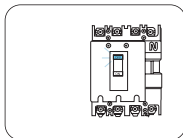

- ⚠ If you want to leave it unused for a long time, turn off the earth leakage circuit breaker.
It can cause electrical shocks or fires.

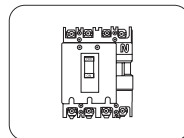

- ⚠ Do not connect many electrical products to the earth leakage circuit breaker. Use it individually.
It can cause fires.

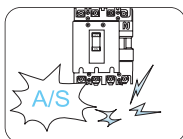

- ⚠ If the power cable is damaged, then do not replace it on your own. Call the service center for cable replacement.
It can cause electrical shocks or fires.

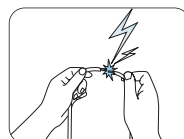

- ⚠ Do not arbitrarily connect the power cord or process it for use.
It can cause fires.

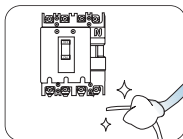

- ⚠ Use a power cable larger than 2.5mm². The control box for the product should be grounded.
It can cause electrical shocks or fires.

Cautions for your safety

Installation related items

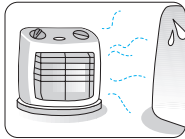

⚠ Do not install it near a heating device.
It can cause fires.

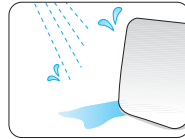

⚠ Do not install it near dust, moisture or rainwater (water) popping.
It can cause electrical shocks or fires.

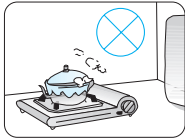

⚠ Do not use or store inflammable gas or material near the product.
It can cause electrical shocks or fires.

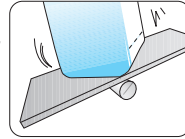

⚠ Do not install it on a tilt. "the appliance has to be placed in a horizontal position" is sufficient.
It can cause physical injury or product damages.

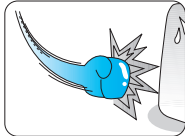

⚠ Do not apply excessive force or impact to the product.
It can cause damages to the product.

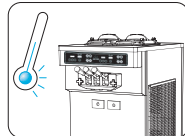

This product shows the best performance at temperature of 10~30°C

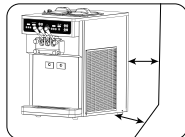

The side and rear of the product should be maintained at least 30cm from the wall.

During use

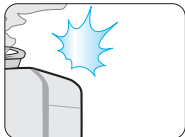

⚠ Do not place candle lights or cigarettes light on top of the product.
It can cause fires.

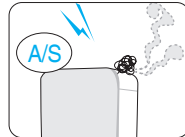

⚠ If the product has weird sounds or burning smell or smoke, turn off the earth leakage circuit breaker immediately and call the service center.
It can cause electrical shocks or fires.

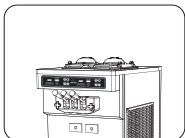

While operating the product, please completely close the upper cap.
Bugs or alien substances can enter the product.

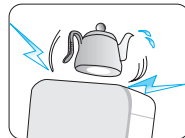

⚠ Do not place water containers, medicine, foods, small metal parts or inflammable material on top of the product.
If they go inside the product, it can cause electrical shocks, fire and damages.

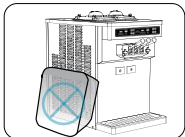

⚠ Do not obstruct the entrance of the air vent.
If so, the performance will be degraded.



⚠ To have good quality soft cream, it is recommended to clean it everyday.
Otherwise, the ingredients can decay.

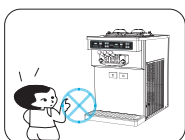

Don't let a person who was not educated the product or a child touch or operate the machine.
Comply with the user guideline suggested by the maker.
Otherwise, it can cause malfunctions



⚠ Please do not press "WASH" button during empty condition which the cylinder doesn't contain any ingredients or water.
The bearing of drum can be frayed because there is no lubrication.



For your information

- Clean the filter periodically. Otherwise, the cooling performance will degrade.
- Comply with the user guideline suggested by the maker. Otherwise, it can cause malfunctions. Don't let a person who was not educated.

Cautions for your safety



This appliance is not intended for use by persons (including children) with reduced physical, sensory or mental capabilities, or lack of experience and knowledge, unless they have been given supervision or instruction concerning use of the appliance by a person responsible for their safety. Children should be supervised to ensure that they do not play with the appliance.

This appliance can be used by children aged from 8 years and above and persons with reduced physical, sensory or mental capabilities or lack of experience and knowledge if they have been given supervision or instruction concerning use of the appliance in a safe way and understand the hazards involved.

Children shall not play with the appliance. Cleaning and user maintenance shall not be made by children without supervision.

This appliance shall be installed in locations where it can be overseen by trained personnel.

This appliance shall be that access to the service area is restricted to persons having knowledge and practical experience of the appliance, in particular as far as safety and hygiene are concerned.

Part names and controller

FRONT

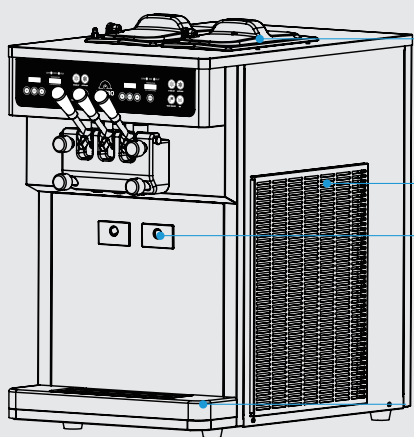

- Cover basket
- Filter condenser (Air cooled type only)
- Drain slug
- Drain box

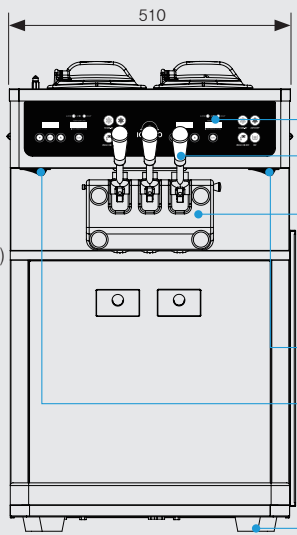

- 510
- Button display
- Lever
- Dasher cover
- Right power switch
- Left power switch
- Rubber foot

LEFT

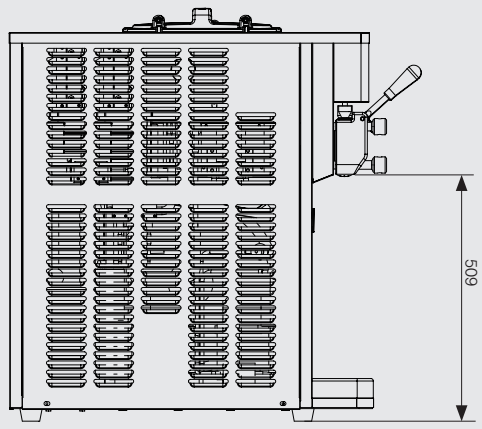

609

RIGHT

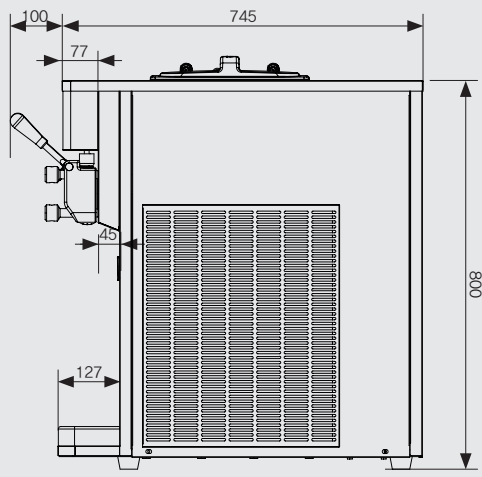

800

Part names and controller



Included accessories

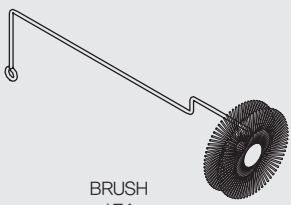

BRUSH
1EA



CARBURETOR TUBE
2EA



CARBURETOR TUBE
BODY
2EA

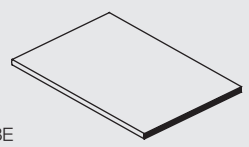

MANUAL
1EA



BRUSH 3
1EA



BEARING DASHER
2EA

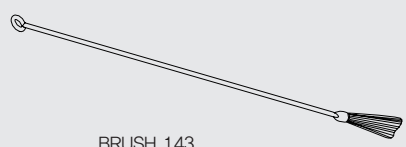

BRUSH 143
1EA

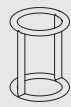

PARTITION FOOD
2EA



DASHER COVER PACKING
2EA

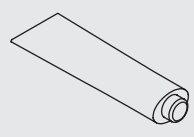

HINES
1EA

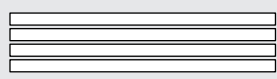

DASHER LUG FOAM
4EA



PACKING DOWN 143
2EA



PACKING CARBURETOR
4EA

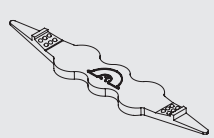

PACKING REMOVE HANDLE
1 EA



PACKING PISTON
2EA

Check prior to use



【 The following must be checked before using the product! 】



Please check the rating of the product before starting installation.

Install it independently with an earth leakage circuit breaker with more than 20A and provide an external grounding.

(Ask a qualified electrical technician for the installation.)

The power cable should be connected before the product can operate normally.

- **Do not block the air vent.**

The air suction and discharge should be facilitated so that the cooling performance can be optimized.

- **Regular filter cleaning (at least once a week)**

Do not skip filter cleaning to ensure good-quality ice cream.

- **The condenser has to be cleaned once a month.**

The daily cleaning of the cylinder, carburetor, hopper, agitator, dasher, piston, and other parts is recommended.

The condenser has to be cleaned more than once a month.

- **Clean it at least once a day.**

The cylinder, mix tank, impeller, dasher, and piston inside the product make contact with the ingredients, so you should clean them once every day.

Button display description and functions

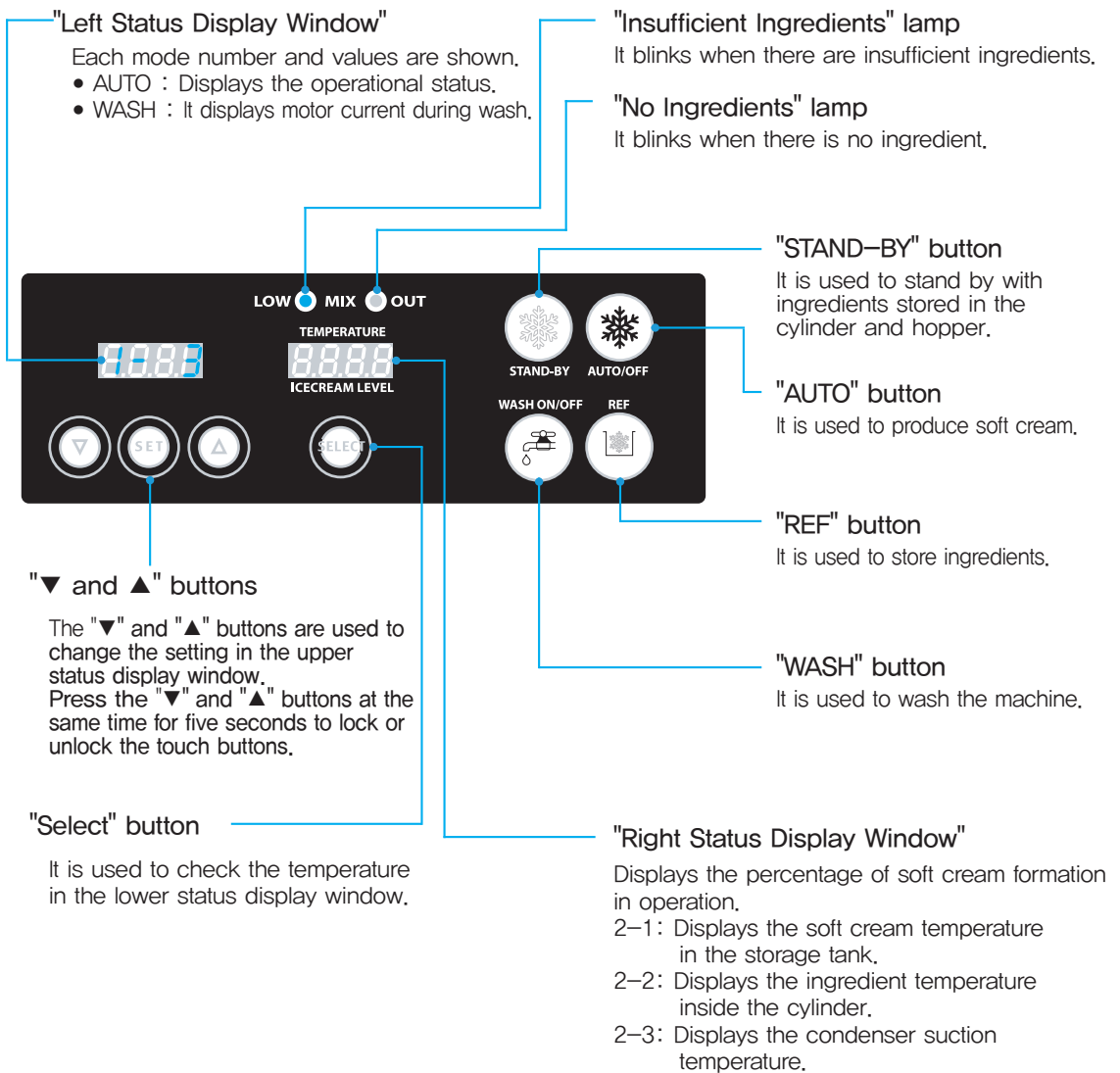

Functional description of the buttons



If you press the "Set" button lightly, you can enter the mode to check the setting as below. Use the "▼" and "▲" buttons to see the settings.

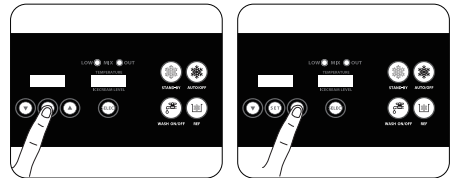

1-1: Check ice cream level settings

You can check the current setting for the ice cream. If the displayed value is higher than the no-load current (1-2), the ice cream becomes harder and if lower, the ice cream becomes softer.



1-2: Check the ice cream default level

It is the no-load current of the dasher motor. It is the current consumed by the dasher motor when the ingredients are in the liquid status.



1-3: Check the currently supplied voltage.

It is the power supplied to the machine. If the voltage is not correct after installation, call for service.



1-4: Check the storage temperature in the mixing tank.

You can check the temperature inside the mixing tank.



1-5: Check the voice announcement

You can check whether a voice announcement is available.



1-6: Check the program version

You can check the versions of the main PCB and the display PCB. "n" is for the main PCB and "d" is for the display PCB.



For Your Information



The soft cream level is set for the ingredients (vanilla) designated by the maker. Depending on the ingredients, you will need to adjust it properly. Please follow the instructions from our company when changing the level for the ingredients.

Functional description of the buttons



Check the temperature and the record

Press the "Select" button to check the different temperature settings mentioned below. The item number and the temperature will be displayed in turns.

- 2-1 : Temperature of the mixing tank
- 2-2 : Temperature of the mixing tank sensor
- 2-3 : Condenser suction temperature (neighboring temperature)

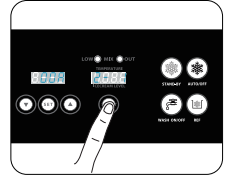

2-1 : Temperature of the mixing tank
The sensor located at the bottom of the mixing tank to measure the temperature of ingredients may display temperatures different from the actual ones if there is no ingredient in the mixing tank or mixer.

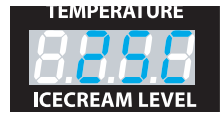



2-2 : Temperature of the cylinder
The sensor located at the bottom front of the cylinder may display temperatures different from those of the ingredients or the ice cream.



2-3 : Ambient temperature of the condenser
The sensor located in front of the condenser can measure the temperature of the ambient air entering the condenser and the recommended installation conditions as well.



 For Your Information  If 2-3 is too high, an error may occur. This error is caused by poor environmental conditions (clearance, cleaning, ventilation, etc.). You should install the machine according to the manufacturer's recommendation.

Functional description of the buttons



Change the setting

Press the "Set" button for three seconds to enter the setting change mode as follows.
Use the "▼" and "▲" to enter the password and use the "Set" button to move to each item. When the display blinks, use "▼" and "▲" to change the value and use the "Set" button to leave the item. Press and hold the "Set" button for three seconds to leave the value change mode.



3-1 : Adjust the soft cream level

This item is used to adjust the target current of the soft cream. If the value is lower, the ice cream becomes softer. If the level is too high, the quantity of produced ice creams may drop, it may not be discharged or other malfunctions may occur. Consult an engineer.



3-4 : Set the mixing tank temperature

This item is used to adjust the cooling temperature of the ingredients in the mixing tank. The larger the number is, the higher the storage temperature is. The smaller the number is, the lower the storage temperature is. If the temperature is too low, the ingredients may freeze. If too high, they may spoil.



3-5-1 : Select a voice announcement option

You can turn on/off the voice announcement.



The ice cream level (3-1) may vary according to ingredients or sugar content. If it is high, the machine operates too much unnecessarily to make the ice cream soft. Also, if the machine stays in the auto mode for two or three hours without discharging any ice cream, this may make the ice cream softer depending on the ingredients.

How to make soft ice cream

1. Open the top cover and pour ingredient into the hopper tank.
※ Fill the ingredient bellow max level.

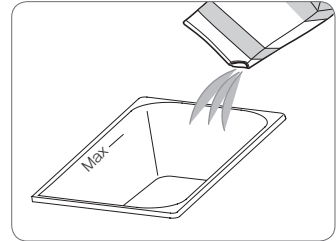

2. After pouring the mix, please insert the carburetor body and carburetor tube into the hole in the hopper.

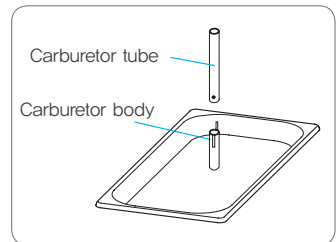

3. Close carburetor hole and apply impellers on the shaft in the hopper.

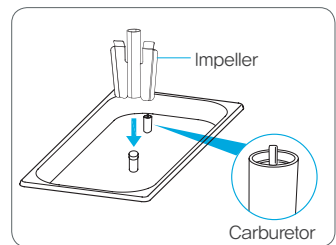

4. Press AUTO button to start making soft ice cream.

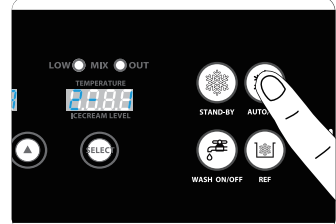

5. Please open the carburetor hole when the ice cream level reaches at 100%.

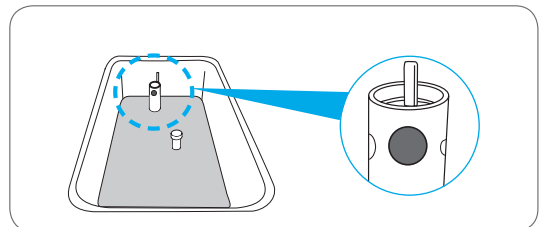

For your information

- The smaller the carburetor hole is, the higher the overrun (air content) is. Instead, in case of continuous sales, the ingredients supply gets slower and the soft ice cream is let out slowly.
- The carburetor hole can get clogged, so check it and wash it periodically during use.
- The manufacturer shall not be responsible for any trouble (e.g., spoilage of materials, overcooling, non-production of ice cream) caused by using materials in non-frozen state (10°C).

How to adjust the carburetor



The carburetor has two components.
 The one inserted into the hopper is "BODY" with a "TUBE" going into the body.
 The tube is open on both sides and cannot be inserted in the wrong direction.

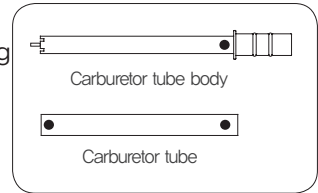

The carburetor hole is opened.
 Match the projecting part on the upper "BODY" to the upper part of the "TUBE" without a hole so that the hole in the lower part of the "BODY" is plugged.
 Conditions : When making ice cream for the first time

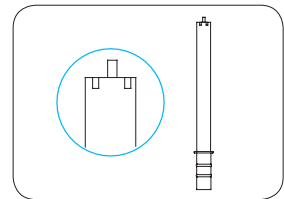

The carburetor is set to a bigger hole.
 Match the projecting part on the upper "BODY" to the big hole in the upper part of the "TUBE" without a hole so that the hole in the lower part of the "BODY" matches the big hole.
 This is to minimize overrun and increase the ingredient for the continuous making of ice cream.
 Conditions : For operation

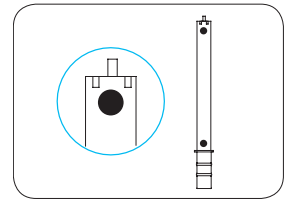

The carburetor is set to a smaller hole.
 Match the projecting part on the upper "BODY" to the smaller hole in the upper part of the "TUBE" without a hole so that the hole in the lower part of the "BODY" matches the smaller hole.
 This is to increase overrun and decrease the ingredient when demand for ice cream is low.
 Conditions : For operation

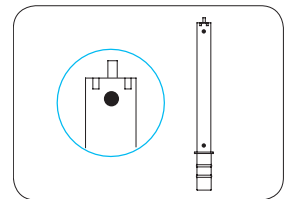

The carburetor is set to a medium-size hole.
 Match the projecting part on the upper "BODY" to the medium-size hole in the upper part of the "TUBE" without a hole so that the hole in the lower part of the "BODY" matches the smaller hole.
 This is to set medium overrun and ingredient.
 Conditions : For operation

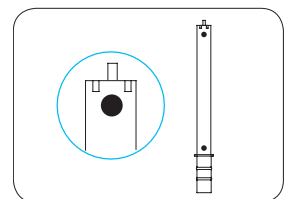



For your information



Even if overrun is improved with a smaller hole, the amount of ice cream may vary depending on the amount of ingredient in the hopper.
 The smaller the amount of ingredient that the hopper has, the bigger the overrun will become, and vice versa.

Cleaning method

【 Wash mode 】

1. Press the wash button on the control panel.
(Wait until the soft cream in the cylinder is melted,
About 10 minutes.)

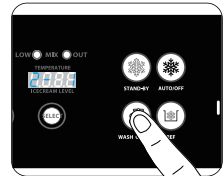

2. Remove the cover basket and
Take out the carburetor (tube+body)
Please do not let water or ice cream mix get
into the agitator shaft.

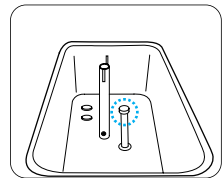
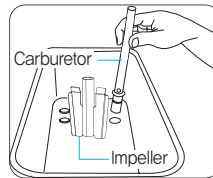

3. Remove the soft ice cream liquid in the mixing
tank and pour faucet water into it.
Repeat it two or three times until you get clean
water from it.

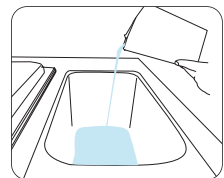
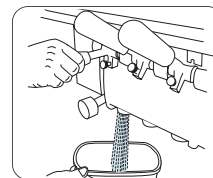

4. Clean out the raw materials and foreign objects from
around the level sensor, drain hole, and so forth from
inside the Mixing tank with a brush.
(The location of the level sensor may be different
depending on model types.)

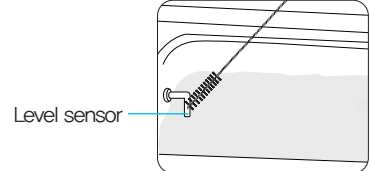

5. Press the 'WASH' button and finally discharge
the water from the mixing tank.
Use faucet water to rinse off the cleaning
agent residuals.

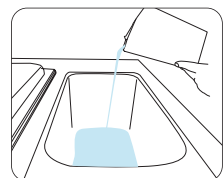
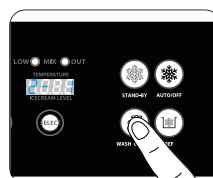

6. Press the wash button to stop the product
and Release the four dasher cover bolts.
(do not turn off the power switch)

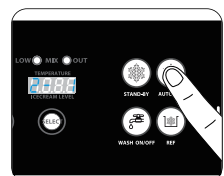

Cleaning method

【 Wash mode 】

7. Separate the dasher cover from the main body.
Disassemble parts of dasher assay.

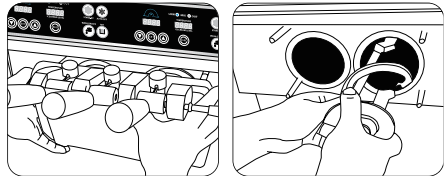

8. Brush off the inner area of the cylinder
and wipe it off with a soft cloth.

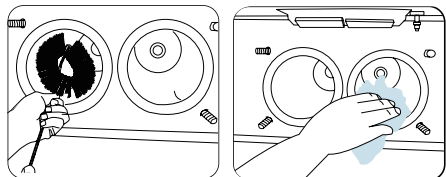

9. Disassemble the dasher assembly, wash
all the parts using neutral detergent
and wipe them with soft cloth.

Dasher lug form

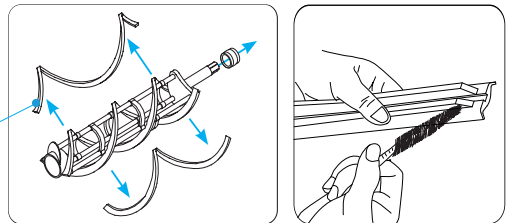

10. Clean up the dasher with a soft cloth.

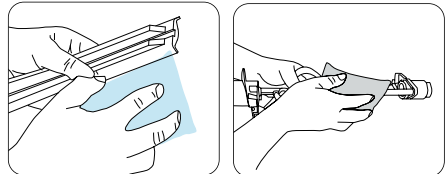

11. Extract a handle shaft and separate the lever
from the dasher cover.

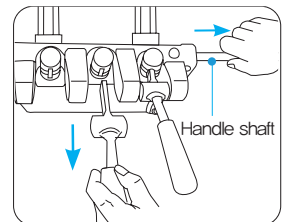

12. Pull out each piston from the dasher cover
and clean it up with brush (Please make sure
not to switch the middle piston with left
and the right piston.)

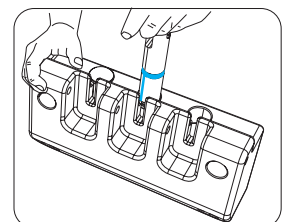

Cleaning method

【 Washing of each parts 】

13. Disassemble the mixing shaft and wipe it off with a brush.

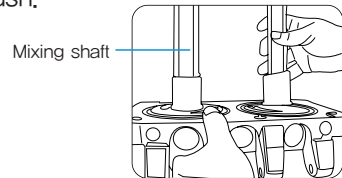

14. Take out the piston of the dasher cover and clean the edge of the piston with a soft towel.

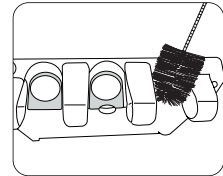

15. After cleaning off all parts, dry them and reassemble them in the reverse order.

【 Condenser and filter cleaning method 】

1. Pull out the condenser filter located on the right side of the machine.

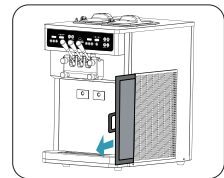

2. Remove dust from the filter element or use a vacuum cleaner, and wash it clean with water.

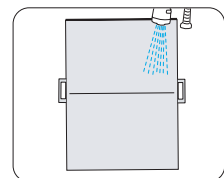

● Clean and dry the filter and insert in into the machine.

3. The condenser surface has lots of dust. Remove it by using a household vacuum cleaner or hand held cleaner. Clean and dry the filter and insert it into the machine.

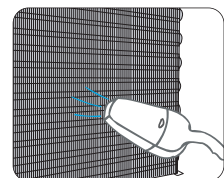

【 Drain slug cleaning method 】

※ One time a week

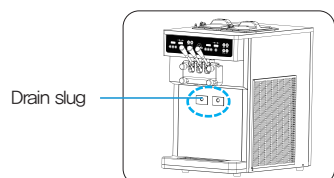

Dasher and dasher cover assembly method



【 Dasher assembly 】

1. Please assemble the blades (LUG POM) on the dasher ass'y.

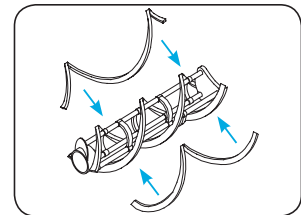
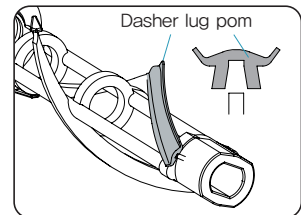

2. Please insert the assembled dasher into cylinder.

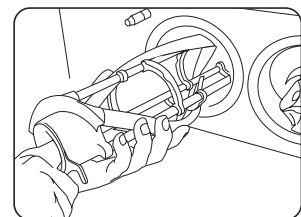

Dasher and dasher cover assembly method

【 Dasher cover assembly 】

1. Apply edible vegetable oil to the ring inserted into the piston.

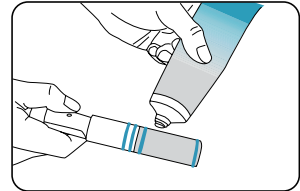

2. Insert the piston in the dasher cover.
 - ※ Please make sure not to switch the middle piston with left and the right piston.
 - ※ When reassembling, the (A) part of the middle piston should be placed as shown in the (Picture 1). When the Partition Food (rubber packing) is inserted fully, please turn the piston to look forehead as shown in the (Picture 2), (Prevention of the rubber from getting entangled)

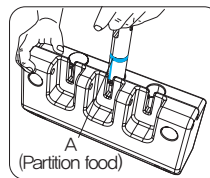

(Picture 1)

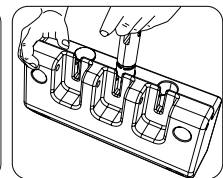

(Picture 2)

3. Insert the discharge lever into the piston and then insert the lever in line with the dasher cover and the discharge lever.

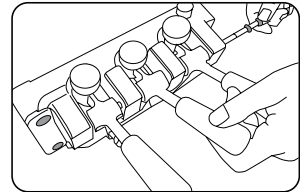

4. Insert the packing dasher to the dasher cover.

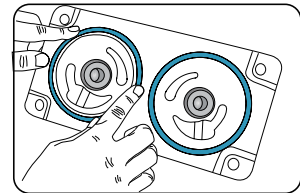

5. Insert the mixing shaft and align the dasher bearing.

Mixing shaft
Dasher bearing

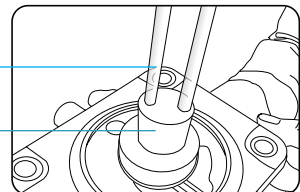

6. Fasten the two pairs of dasher cover bolts facing each other diagonally.
If they are loose, then the soft cream can leak. Fasten it tightly.

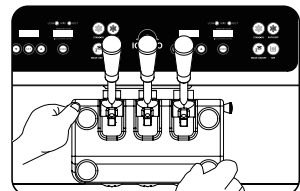

Installation method

【 Electrical connection 】

1. Please set up the earth leakage circuit breaker box for only the machine (above AC 20A for 1phase) and connect electricity.

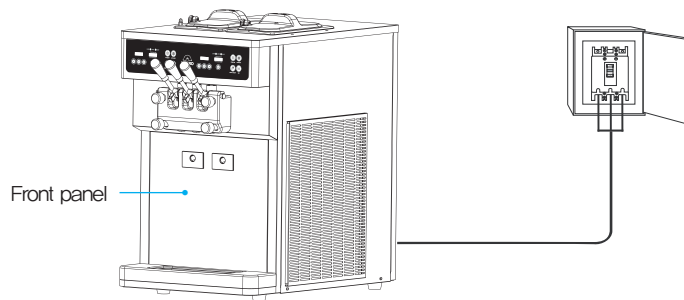

2. They should match the voltage displayed in 1–3. If not, then using a straight headed driver, adjust the PCB variable resistance located in the control box at the front of the product as shown in the figure.

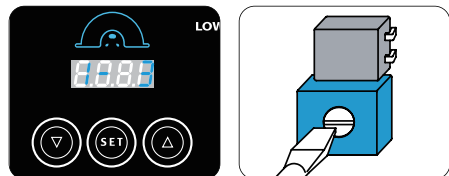

※ Making Mode : The equipment shall only be connected to a supply with a system impedance of lower than 0.034 Ohms, in accordance with EN 61000-3-11:2000 – Section 6.2.2

Standby Mode : The equipment shall only be connected to a supply with a system impedance of lower than 0.22 Ohms, in accordance with EN 61000-3-11:2000 – Section 6.2.2

'Instruct the user to determine in consultation with the supply authority that the equipment is connected only to a supply of that impedance or less.'

For your
information



Electrical connections should be performed by an electrical technician to make sure that each phase is (L, N, GROUND) correctly connected. If the connection is wrong, it can cause explosions or ignition of the PCB in the product and electrical shocks or fires.

Before requesting service

The soft ice cream maker can operate abnormally because you are not familiar with the method for use or due to another insignificant reason. It does not necessarily mean a malfunction. In this case, check the following items to resolve a simple problem on your own without the help from the service center. If you still can't resolve it after checking the following items, please contact our service center.

State	Please check
The machine does not work!	<ol style="list-style-type: none"> 1. Contact an electrician or the customer satisfaction team in case a phase error occurred. 2. Check whether the ELB and switch are turned off. 3. In case the display (front display) is on, turn the ELB (breaker) and switch on.
Does not stop but continues to operate!	<ol style="list-style-type: none"> 1. Check whether dust is stacked in the ventilation hole. Take out the filter and remove the dust. 2. If the machine is close to the wall and has no ventilation, it can stop. Please, secure it at least 30cm from the wall. 3. Check whether the carburetor hole is blocked and if so clean out the hole. 4. Check whether the temperature in the ventilation hole (inhalation hole) is high. Set the inhalation temperature of the condenser lower than 38°C.
Soft ice cream is thin!	<ol style="list-style-type: none"> 1. Check whether the carburetor is inserted. 2. In case there are no sales for more than 3 hours, the soft ice cream can be melted and made one more time by using the recycling function (cover the carburetor hole during recycling).
The noise is disturbing!	<ol style="list-style-type: none"> 1. This product is an industrial machine and has some operation noise when compared to household appliances. This product is designed to generate noise that is less than 70dB. the customer satisfaction team in case abnormal noise is generated during machine operation. 2. A clicking sound can be generated during the initial operation. This is the sound of plastic blade (dasher blade) that cleans the wall of the cylinder while making soft ice cream.
Soft ice cream dose not come out enough!	<ol style="list-style-type: none"> 1. Is the raw material need lamp blinking? In the case of MIX LOW, the ejection amount can become small. In the case of MIX LOW, replenish the raw material. 2. The ejection amount can change by carburetor hole. The ejection amount can be large when a large hole is used. 3. Did you set up ice cream level too high? (If you increase the level, you may have lower amount of ice cream, If you decrease the level, you may get more amount of ice cream)
Soft ice cream comes out too much!	<ol style="list-style-type: none"> 1. Soft ice cream becomes thin and ejection amount may become large as time passes. Remake soft ice cream by using the recycling function to solve the problem. 2. Ejection amount can change by carburetor hole. The ejection amount can be small when a small hole is used. 3. Did you set up ice cream level too low? (If you control a high level, you may have lower amount of ice cream, If you control a low level, you may get more amount of ice cream) If setting up the ice cream too high, no ice cream can be discharged
Overrun is not working correctly.	<ol style="list-style-type: none"> 1. Be sure to familiarize yourself with the user instruction. 2. Overrun will be improved by replacing the carburetor with one having smaller holes. 3. In case to operate the machine for a long time, If soft serve mix left 2/3 capacity of cylinder, it may cause bad overrun, therefore to increase it, please draw about half amount of the soft serve mix and then please make new ice cream. After that, you can produce soft ice cream with good overrun. But, if there is less than 1/3 amount of ice cream in cylinder, it might cause over freezing and can't draw any soft ice cream.
When having bad texture of soft ice cream	<ol style="list-style-type: none"> 1. When you use soft ice cream ingredient with high milk fat, it makes a bit of milk fat chunk inside ice cream. If you have low sales volume, please adjust the carburetor hole at the smallest hole to prevent from it.
Soft ice cream has gone bad.	<ol style="list-style-type: none"> 1. This product must be cleaned daily. The remaining raw material must be wasted and new raw material must be used to make Soft ice cream. The manufacturer is not responsible if this is not observed.
When having dark color of ice cream	<ol style="list-style-type: none"> 1. Did you insert the carburetors? You can make good overrun when using small size carburetor hole. 2. You can make soft ice cream with good overrun by opening carburetor hole and by discharging (drawing) ice cream several times.

Error code types

The soft ice cream maker may malfunction due to incorrect operation procedure or a trivial cause other than machine defect or failure. If the following corrective actions fail to correct the problem, or the error code is not presented below, or the same error persists, contact the nearest After Service Center.

※ Before contacting the After Service Center, turn power off, wait for five minutes, then turn power on and start the machine again.

Error code		Error details	Error occurrence	Release condition	Display
Er 1	hoPn	Cooling temperature sensor is bad.(Open)	Stop	Auto release	Continuous display
Er 2	hSht	Cooling temperature sensor is bad.(Short)	Stop	Auto release	Continuous display
Er 3	CoPn	Cooling cylinder entrance's temperature	Stop	Auto release	Continuous display
Er 4	CSht	Cooling cylinder entrance's temperature	Stop	Auto release	Continuous display
Er 5	AoPn	Condenser suction temperature sensor is bad. (Open) But it operates when 4-11 (neighboring temperature selection) is on.	Start	Auto release	5 minute interval
Er 6	ASht	Condenser suction temperature sensor is bad. (Short) But it operates when 4-11 (neighboring temperature selection) is on.	Start	Auto release	5 minute interval
Er 7	EoCr	Over current of the dasher motor and current detection failure.	Stop	Reset	Continuous display
Er 8	HiPS	High pressure detected.	Stop	Auto release	Continuous display
Er 9	noLA	Soft ice cream is not formed.	Start	After a dormancy	Continuous display
Er 10	Lovo	Supply voltage exceeding -15%.	Stop	Auto release	Continuous display
Er 11	Hivo	Supply voltage exceeding +15%.	Stop	Auto release	Continuous display
Er 12	drAU	Bad location of the out lever.	Start	Auto release	5 minute interval
Er 13	Hott	Condenser suction temperature too high.	Start	Auto release	5 minute interval
Er 14	bELt	Axial power is abnormal.	Stop	Reset	Continuous display
Er 15	EEP1	Main PCB EEPROM is abnormal.	Start	Reset	5 minute interval
Er 16	dAtA	Data communication failure.	Stop	Auto release	Continuous display

Wiring diagram

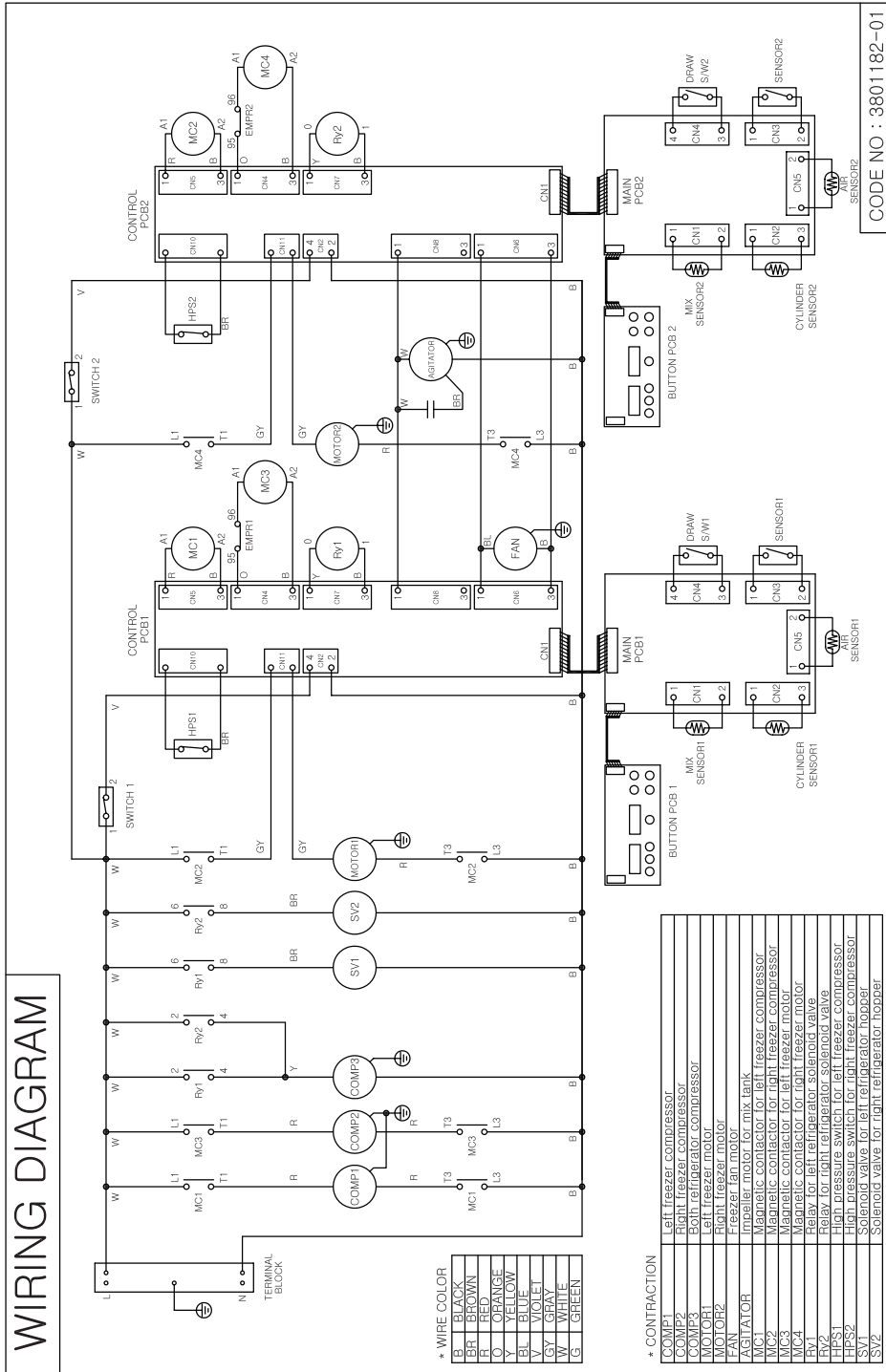

Service for Refrigerant Lines

Removal and replacement of freezing parts

CAUTION

1. This unit should be diagnosed and repaired only by qualified service personnel to reduce the risk of death, electric shock, serious injury, or fire.
2. Move the ELCB switch to the "OFF" position before servicing
3. CHOKING Hazard : Ensure all components, fasteners, and screws are securely in place after the unit is serviced.
4. Make sure hopper and cylinder in the ice-cream maker are clean after the unit is serviced.

A. Service for Refrigerant Lines

WARNING

1. Repairs requiring the refrigeration circuit to be opened must be performed by Properly tarined service personnel.
2. Always recover the refrigerant and store it in an approved container.
Do no discharge the refrigerant into the atmosphere.
3. Use an electronic leak detector or soap bubbles to check for leaks.
Add a trace of refrigerant to the system (if using an electronic leak detector), and then raise the pressure using nitogen gas (140PSIG).
DO NOT use R-404A as a mixture with pressurized air for leak testing

CAUTION

1. The Polyol Ester (POE) oils used in R-404A units can sbsorb moisture quickly. Therefore it is important to prevent moisture from entering the system when replacing or servicing parts.
2. Always install a new drier every time the ealed refrigeration system is opend.
3. Do not replace the dried until after all other repair or replacement has been made.
Install the new drier with the arrow on the drier in the direction of the refrigerant flow
4. When brazing, protect the drier and 4-way valve by using a wet cloth to prevent the drier and 4-way valve from overheating, Do not allow the drier to exceed 250°F (121 °C)
5. Do not leave the system open for longer than 15 minutes when replacing or servicing parts.

Service for Refrigerant Lines



1. Refrigerant Recovery

This ice cream vending machine has a refrigerant service valve (nipple). Recover the refrigerant through this nipple and keep the recovered refrigerant in an approved storage bin. Never discharge the recovered refrigerant to the atmosphere.

2. Brazing

WARNING

1. R-404A itself is not flammable at atmospheric pressure and temperatures is to 176°F(121 °C)
2. R-404A itself is not explosive or poisonous. However, when exposed to high temperatures (open flames), R-404A can be decomposed to form hydrofluoric acid and carbonyl fluoride both of which are hazardous.
3. Do not use silver alloy or copper alloy containing arsenic.
4. Use an electronic leak detector or soap bubbles to check for leaks. Add a then raise the pressure trace of refrigerant to the system (if using an electronic leak detector), and using nitrogen gas (140PSIG). DO NOT use R-404A as a mixture with pressurized air for leak testing

1) When brazing copper pipe, purge the pipe with nitrogen gas at pressure of 3~4 psig.

CAUTION

1. Always install a new drier every time the sealed refrigeration system is opened.
2. Do not replace the drier until after all other repair or replacement has been made. Install the new drier with the arrow on the drier in the direction of the refrigerant flow
3. When brazing, protect the drier and 4-way valve by using a wet cloth to prevent the drier and 4-way valve from overheating, Do not allow the drier to exceed 250°F (121 °C)

2) Use an electronic leak detector or soap bubbles to check for leaks. Add a trace of refrigerant to the system (if using an electronic leak detector), and then raise the pressure using nitrogen gas (140PSIG). DO NOT use R-404A as a mixture with pressurized air for leak testing.

Service for Refrigerant Lines



3. Vacuuming and recharging (R-404A)

- 1) Install the vacuum pump on the system. Connect the charging hoses on the charging nipples of both high-pressure and low-pressure ends.



IMPORTANT

The vacuum level and vacuum pump may be the same as those for current refrigerants. However, the rubber hose and gauge manifold to be used for evacuation and refrigerant charge should be exclusively for POE oils.

- 2) Turn the vacuum pump on and open the manifold valve.
The oil of the vacuum pump shall not be allowed to leak into the system.
- 3) Wait until the desired vacuum level is obtained. Vacuuming time may vary depending on the capacity of the vacuum pump.
- 4) Open the manifold valves on the high- and low-pressure ends.
- 5) Remove the manifold hose from the vacuum pump and connect the hose to the refrigerant service cylinder. Purge air from the hose with the hose kept slightly open. Use pure refrigerant with no foreign materials.
- 6) The use of liquid refrigerant is recommended.
Turn the service cylinder upside down on a scale and open the manifold valve on the high-pressure end.
- 7) Wait until an adequate amount of refrigerant is injected.
- 8) If necessary, inject the remaining refrigerant into the low pressure-end. Inject refrigerant into the low-pressure end while the system operates.
- 9) Close the manifold valves on the high- and low-pressure ends. Remove the manifold hoses.
- 10) Reattach the caps on the nipples.

Removal and Replacement of Compressor



B. Removal and Replacement of Compressor



WARNING

1. Always install a new drier every time the sealed refrigeration system is opened.
2. Do not replace the drier until after all other repair or replacement has been made.
Install the new drier with the arrow on the drier in the direction of the refrigerant flow
3. When brazing, protect the drier and 4-way valve by using a wet cloth to prevent the drier and 4-way valve from overheating, Do not allow the drier to exceed 250°F (121 °C)

When replacing the compressor with defective winding, replace the start capacitor and the start relay as well.

The compressor shall be replaced and serviced within 15 minutes since the POE oil inside the compressor rapidly absorbs moisture.

- 1) Turn off the power of ELCB.
- 2) Open the side door.
- 3) Recover the refrigerant using an adequate vessel.
- 4) Remove the terminal cover of the compressor and disconnect the compressor cable.
- 5) Remove the discharge and the suction pipes.
- 6) Remove the bolts, washers, and rubber grommets from the compressor.
- 7) Remove the compressor. Remove the packaging of the new compressor.
- 8) Insert the rubber grommets in the new compressor.
- 9) Place the compressor on the system and assemble it on the system by tightening the bolts and the washers.
- 10) Replace the drier with a new one.
- 11) While purging with nitrogen gas at pressure of 3-4 psig, braze the copper connections.
- 12) Inject nitrogen at pressure of 140 psig and check for leaks with electric leak detector or soap water.
- 13) Vacuum the system and inject the refrigerant.
- 14) Connect the terminal and assemble the terminal cover on its position.
- 15) Close the side door.
- 16) Turn on the power of ELCB.

Removal and Replacement of Capillary Tube

C. Removal and Replacement of Capillary Tube

CAUTION

1. Always install a new drier every time the sealed refrigeration system is opened.
2. Do not replace the drier until after all other repair or replacement has been made.
Install the new drier with the arrow on the drier in the direction of the refrigerant flow
3. When brazing, protect the drier and 4-way valve by using a wet cloth to prevent the drier and 4-way valve from overheating, Do not allow the drier to exceed 250°F (121 °C)

- 1) Turn off the power of ELCB.
- 2) Open the side door.
- 3) Recover the refrigerant using an adequate vessel.
- 4) Remove the capillary tube and install a new one.
- 5) Replace the drier with a new one.
- 6) While purging with nitrogen gas at pressure of 3~4 psig, braze the copper connections.
- 7) Inject nitrogen at pressure of 140 psig and check for leaks with electric leak detector or soap water.
- 8) Vacuum the system and inject the refrigerant.
- 9) Close the side door.
- 10) Turn on the power of ELCB.

Removal and Replacement of Condenser'



E. Removal and Replacement of Condenser'



WARNING

1. Always install a new drier every time the sealed refrigeration system is opened.
2. Do not replace the drier until after all other repair or replacement has been made.
Install the new drier with the arrow on the drier in the direction of the refrigerant flow
3. When brazing, protect the drier and 4-way valve by using a wet cloth to prevent the drier and 4-way valve from overheating, Do not allow the drier to exceed 250°F (121°C)

- 1) Turn off the power of ELCB.
- 2) Open the side door.
- 3) Recover the refrigerant using an adequate vessel.
- 4) Remove the condenser filter, if any.
- 5) Remove the inlet and the outlet from the condenser.
- 6) Open the back panel cover.
- 7) Remove the harness from the fan motor.
- 8) Remove the four screws from the fan motor assembly.
- 9) Remove the screws fastening the bracket that fixes the condenser (total of 4 screws on the left and the right).
- 10) Replace the condenser with a new one.
- 11) Tighten the screws fastening the bracket that fixes the condenser (total of 4 screws on the left and the right).
- 12) Replace the drier with a new one.
- 13) While purging with nitrogen gas at pressure of 3~4 psig, braze the copper connections such as the condenser inlet and outlet.
- 14) Inject nitrogen at pressure of 140 psig and check for leaks with electric leak detector or soap water.
- 15) Vacuum the system and inject the refrigerant.
- 16) Tighten the four screws from the fan motor assembly.
- 17) Connect the harness to the fan motor.
- 18) Tighten the screws on the back panel cover.
- 19) Close the side door.
- 20) Turn on the power of ELCB.

Replacement of Fan motor



F. Replacing the fan motor

- 1) Turn off the power of ELCB.
- 2) Open the back panel cover.
- 3) Remove the harness from the fan motor.
- 4) Remove the four screws from the fan motor assembly.
- 5) Remove the fan motor and the fastening brackets (total of four bolts).
- 6) Replace the motor with a new one.
- 7) Assemble the fan motor and the fastening brackets (total of four bolts).
- 8) Tighten the four screws from the fan motor assembly.
- 9) Connect the harness to the fan motor.
- 10) Tighten the screws on the back panel cover.
- 11) Turn on the power of ELCB.

Refrigerant circuit

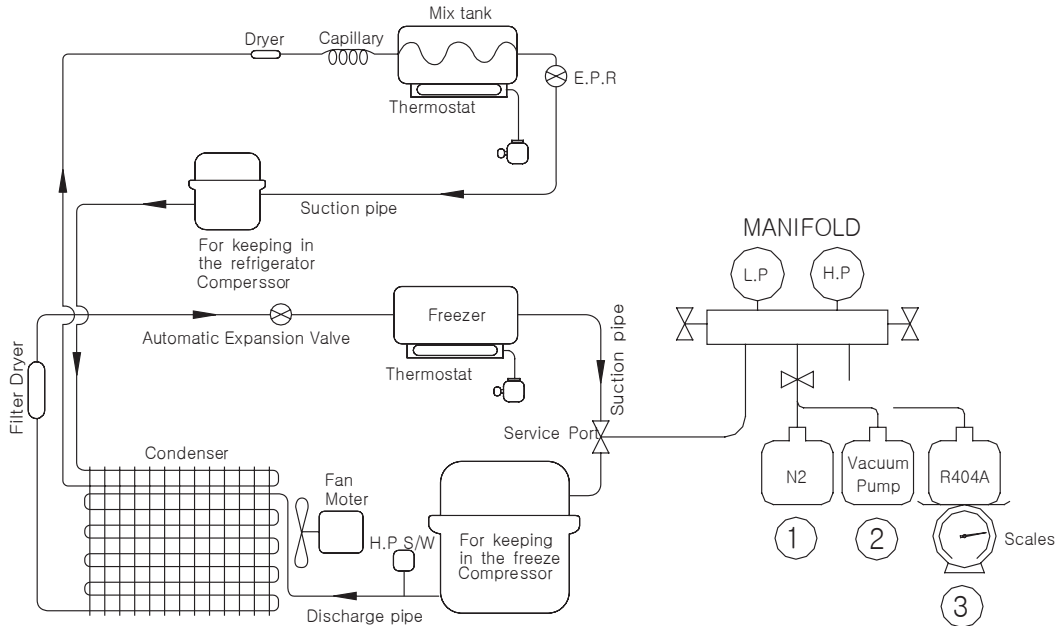

■ Charging Refrigerant ■

① Leak Test

When the refrigeration system is opened to repair or service the refrigerant system, conduct leak test before vacuum work, at the expanded and welded tube joints.

- 1) Connect the manifold gauge to the low-pressure service port, and connect nitrogen gas tank to the manifold gauge
- 2) When the manifold gauge indicates 300 PSIG, close the valve.
- 3) Perform leak test with the entire refrigerant system.
- 4) If there is no leakage, close the manifold and disconnect the nitrogen gas tank.

② Vacuum

Remove the moisture and air from the refrigerant system before charging refrigerant.

- 1) Connect vacuum pump with the manifold gauge, and start the vacuum pump.
- 2) The vacuum time shall be at least 30 minutes and the manifold pressure shall be maintained at 740~750mmHg.
- 3) When full vacuum state is reached, close the manifold gauge and disconnect the vacuum pump.

③ Charging Refrigerant

- 1) Connect refrigerant container to the manifold.
- 2) Open the refrigerant container valve slightly and purge the air from the manifold hose.
- 3) Measure the gross weight of the refrigerant container using a balance.
- 4) Place the refrigerant container upside down, with the valve at the bottom. Wait until the refrigerant stabilizes. Open the valve to charge the refrigerant.
- 5) When the refrigerant has been fully charged, disconnect the manifold.

Product specification

CLASSIFICATION		SPECIFICATION	
Product name		Soft Ice Cream Maker	
Model name		ISI-163TT	
Rated voltage and frequency		220V, 60Hz	230 V~, 50 Hz
Rated current		15.6 A	12.7 A
Product size (foot inclusion, cover excluded) (mm)	HEIGHT	800	
	WIDTH	510	
	DEPTH	745 (Lever excluded)	
Cylinder capacity(L)		1.4 X 2	
Mixing tank capacity		5.5 X 2	
Consecutive selling (At interval of 30 seconds)		5 X 2	
Cooling temperature		Can keep under 10 °C	
Ingredient sensor		Applied	
FILTER		Applied	
Product weight (kg)	Before packing	179	
	After packing	195	
Refrigerant Material (g)	Freezer (R-404a)	400	570
	Refrigerant (R-134a)	80	86

※ NOTE : 220 V, 60 Hz – ETL Certified model
230 V~, 50 Hz – CE/CB Certified model

Part list



【 MOVING PART 】

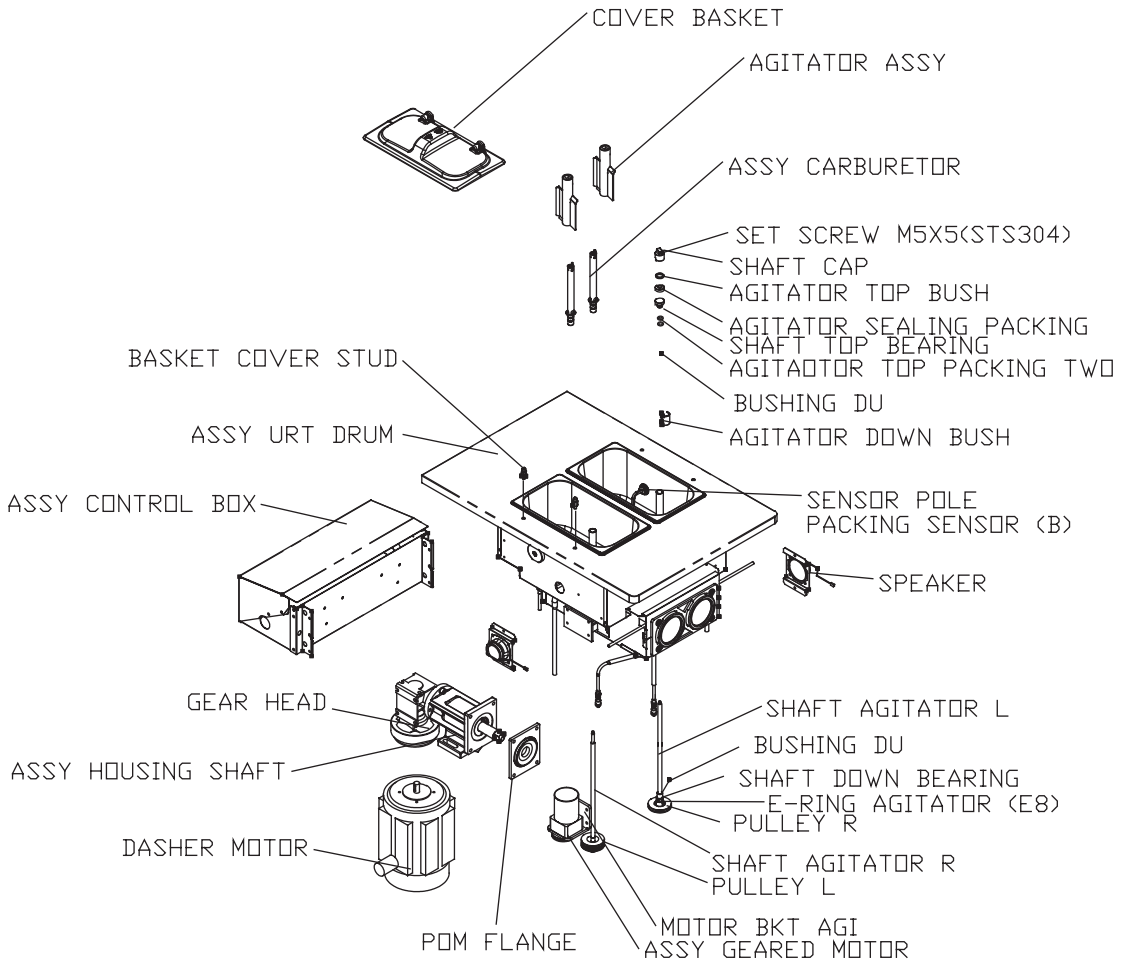

Part list



【 DASHER ASS'Y 】

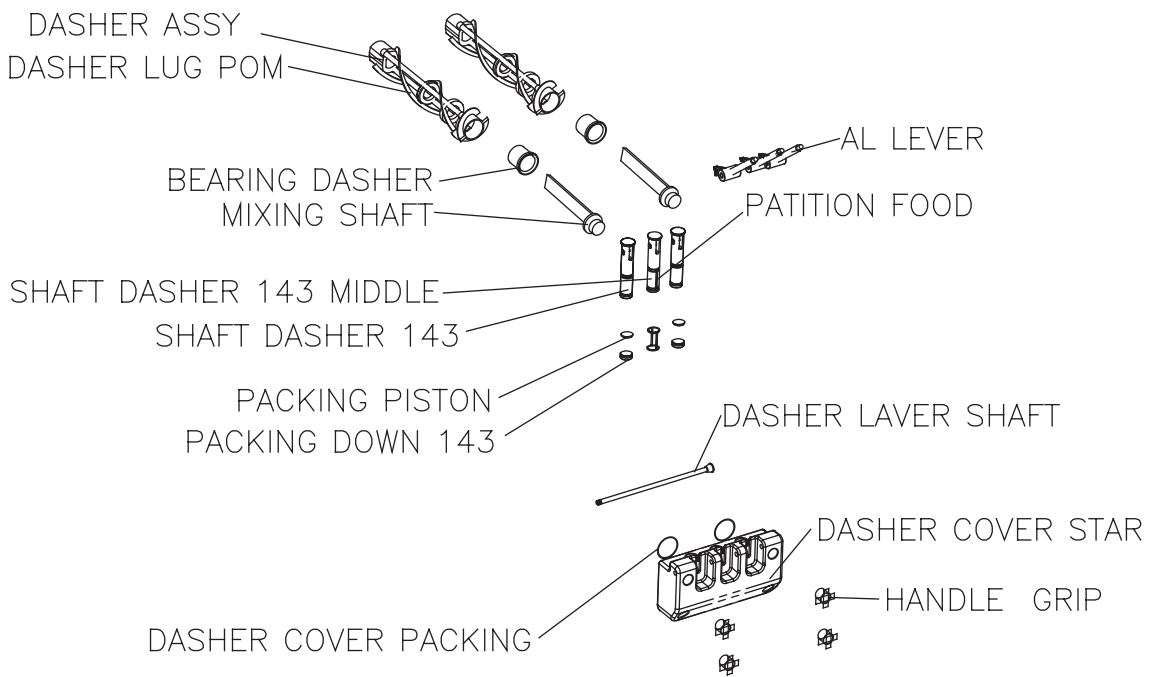

Part list



【 COMPRESSOR AND CONDENSER 】

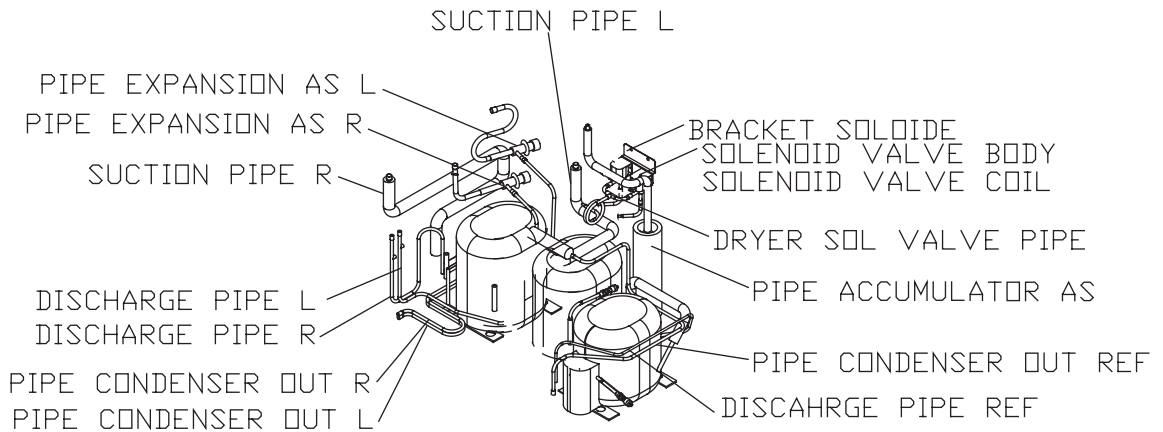
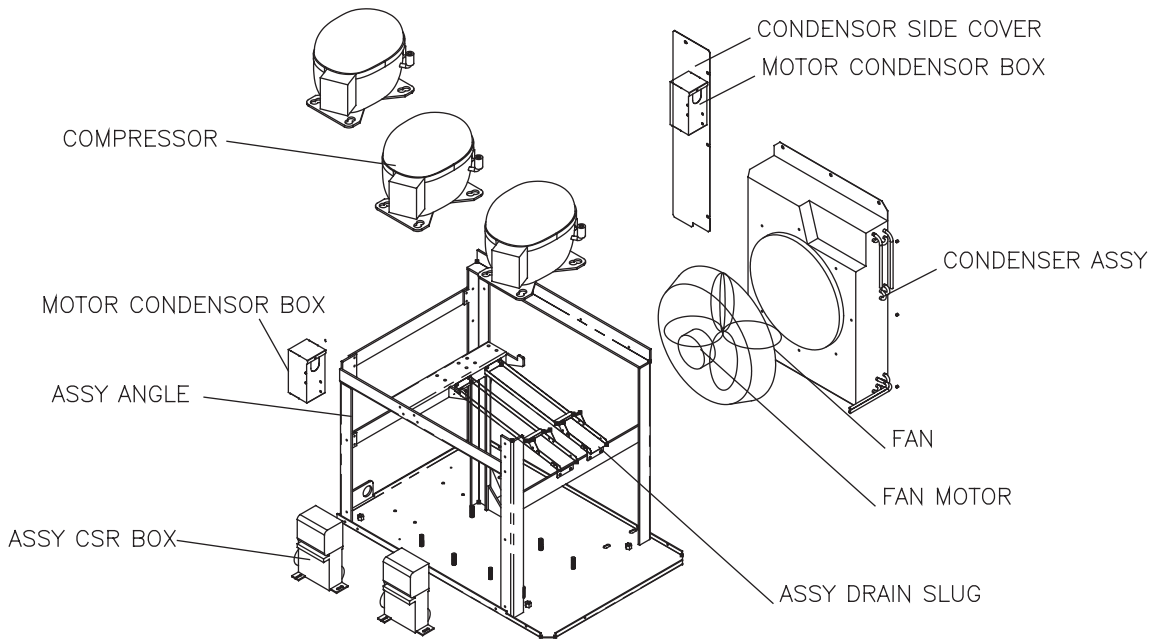

Part list



【 FRONT COVER ASS'Y 】

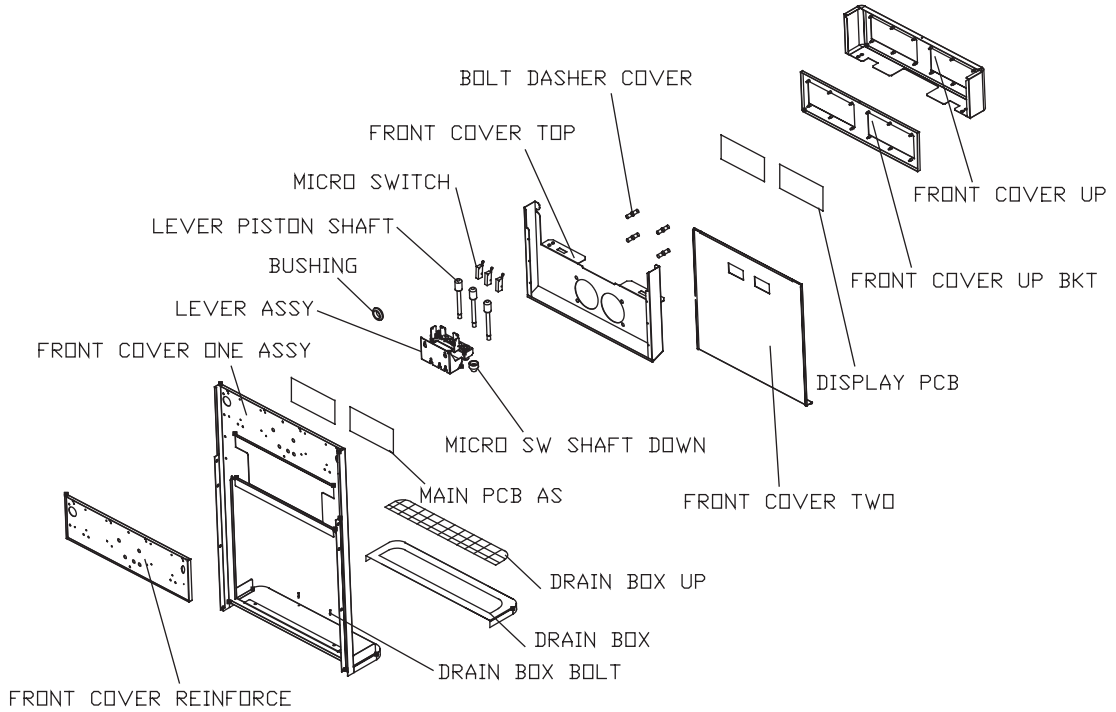

【 SIDE & BACK PANEL ASS'Y 】

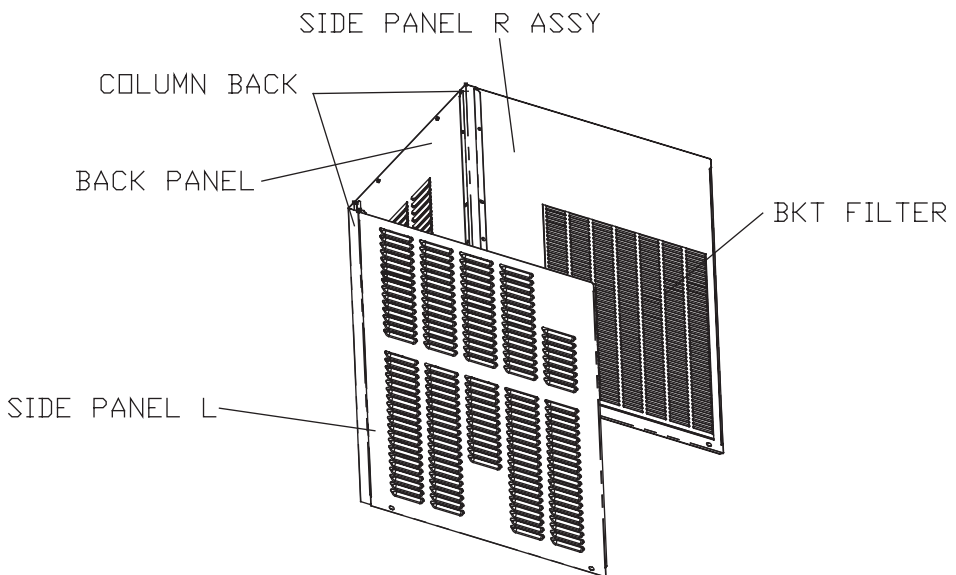

What to watch out for



Overcooling may give rise to issues such as unintended stopping of operation, damage to the product itself or any part, or malfunction of the power delivery axis.
There may be excessive noise or smell due to abrasion. Any issue inside the product may result in the formation of foreign object in the ice cream.
Refer to the main causes of overcooling for safe operation.

1. Using the exclusive liquid ingredient supplied by the manufacturer is recommended. Mixing powdered ingredient with water or milk must be done based on the ratio recommended by the manufacturer.
(The ice cream maker makes ice cream with appropriately mixed ingredients. Powdered ingredient may cause precipitation or separation of ingredients, leading to overcooling. Making ice cream under such conditions will cause more issues with ice cream.)
2. Mixing the recommended ingredient with other additives or arbitrarily adjusting the mixing ratio of a diluted ingredient may lead either to the proper icing of ice cream or to overcooling. The manufacturer is not liable for any issue arising from improper use or mixing of ingredient. Be sure to check and follow the diluting ratio.
3. Mixing of powdered ingredient must be done by hand slowly.
If mixing is done fast with the maker, too much oxygen may get into the mixture, resulting in oxidization or clotting of ingredient.
In such case, the ingredient will coagulate into a form similar to soft tofu, causing difficulty in the supply of ingredient and overcooling.
4. If ingredient is not supplied normally to the inside of the drum where ice cream is made, leading to lack of ingredient, overcooling may occur.
Check the amount of ingredient frequently to prevent such issues.
Even if enough ingredient is in the hopper, coagulation may cause the clogging of the carburetor (mixing valve) that supplies the ingredient to the drum and prevent the proper supply of ingredient.
Be sure to remove and clean the carburetor frequently.
5. If the maker is not used for an extended period of time, the waiting time of the ingredient is extended, causing freezing in the hopper as well as separation of fat in the process of making or keeping ice cream during the waiting time.
In such case, ice cream may get too thin, or the maker may be overcooled.
Be sure to operate the maker regularly even though there is no demand for ice cream to prevent such waiting time.
6. Repeated use of ingredient may deteriorate the quality of ice cream and cause overcooling. Be sure to refill with new ingredient after cleaning instead of reusing the old one.
7. You can increase quality of ice cream by controlling 3-1 setting value(ice cream setting value) when using high sugar rated ingredient.
8. Ice could be formed inside the hopper when there is insufficient ingredient.
It could be prevented by raising the hopper setting temperature.

Warranty



If no receipt or warranty certificate is received, the receipt/warranty certificate is lost, or the date of purchase cannot be confirmed for reasons other than the foregoing, the warranty expires within 6 months of the manufacturing date.

[Free repair]

1. For issues with functions or performance during normal usage within the warranty period

[Paid repair]

1. If the warranty has expired
2. If installation is required again due to incorrect installation by the customer or the store
3. If installation is required again due to the relocation of product or moving of the customer
4. If the malfunction is not attributable to the product
5. If the wrong power specification is applied
6. If any accessory or consumable other than that recommended by the manufacturer is used
7. If damage is caused by external force or dropping of the product
8. If damage is caused by natural disaster such as lightning, fire, earthquake, storm, typhoon, etc.
9. If any accessory/consumable goes obsolete or its service life comes to an end (packing, o-ring, blade, cleaning brush, etc.)
10. If foreign object is put into the product such as water, beverage, coffee, toy, etc.)
11. If external force is applied during installation or usage, causing damage or malfunction
12. If any accessory/consumable other than that made by the manufacturer is used
13. If directions for installation or standards are not followed
14. If the customer arbitrarily disassembled and lost or damaged any part
15. If a person other than an authorized engineer from the manufacturer repairs or modifies the product
16. If malfunction is caused by failure to follow the "Safety warning / caution" on the user manual
17. If the water supply pipe froze and burst

온라인 인터넷 서비스
<http://www.icetro.com>

