

# FLAKE ICE MAKER USER MANUAL

## MODEL : IM-0770-AF, AN

---

- ※ This machine cannot be used in any other country where the electric voltage for its power supply is not available.
- ※ This product is designed for indoor installation. Please be sure to install it indoors.
- ※ The external appearance, design, color, and/or components of this machine may be changed without prior notice for the sake of the Company's product manufacture.
- ※ For maximum hygiene, be sure to clean and sterilize the product on a daily basis.

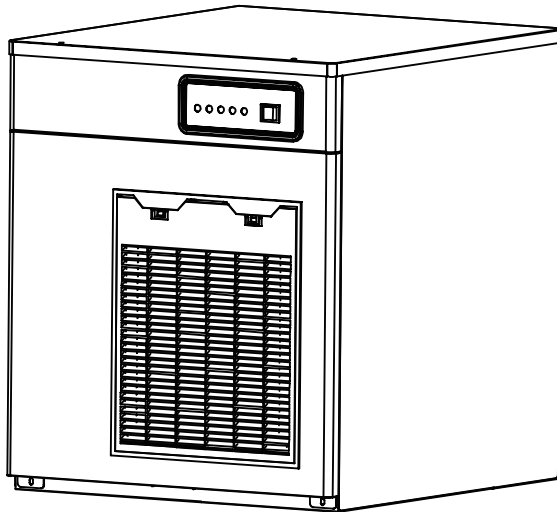



# INDEX

---

1. Preparations for safety .....	3~7
2. Specifications .....	8
3. Part names .....	9~10
4. Installation .....	11~18
– Suitable installation condition and place .....	11~12
– How to disassemble the panels .....	13
– How to install the storage bin .....	14
– Installing the ice maker and connecting storage bin .....	14~15
– How to connect water inlet and outlet hoses .....	16
– About grounding .....	17
– After installation .....	18
– Electrical Connection .....	19
5. Starting the product .....	20~21
– Ice making .....	20
– Water outlet(evaporator) .....	20
– Stopping the product .....	21
6. Product Status Indication Lamp Guide .....	22
7. Essential measures to prevent freezing and bursting .....	23
– Make sure to remove water from the water supply tank and the evaporator .....	23
8. Maintenance, clearing and sterilizing .....	24~28
– Maintenance schedule .....	25
– Cautions for cleaning the external panel(stainless steel) .....	26
– Cleaning / Sterilizing .....	27~28
9. Error type .....	29
10. Before contacting the manufacturer .....	30

# 1. Preparations for safety

 <b>Warning</b>	Failure to follow these instructions may result in severe personal injury or death.
 <b>Caution</b>	Failure to follow these instructions may result in parts replacement expense and / or service repair expense.



SHOULD BE DONE



PROHIBITION



DO NOT  
DISASSEMBLE



DO NOT  
TOUCH



DISCONNECT  
POWER PLUG



GROUNDED

## Warning

Use a single receptacle for the ice machine.

- ◆ An electrical fire may be caused by a receptacle holding more than one item.
- ◆ Do not use an adapter or an extension cord.

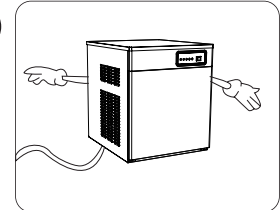

## Warning

**Do not place or store heavy items on the top of the product.**

- ◆ Damage by excessive weight can cause the unit to overheat and/or fire.

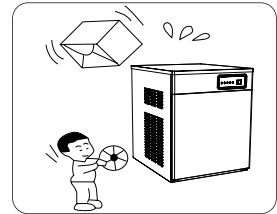

**Do not install the machine under humidity area or near the water sprayed zone.**

- ◆ Lack of insulation cause a electric leakage, shock and fire.

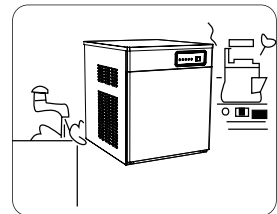

**Stop the operation**  
When the smell of something burning or smoke is emitted from the machine, or if the product malfunctions, immediately unplug the product and stop operation.

- ◆ Operating the product under bad conditions may cause fire or electric shock.

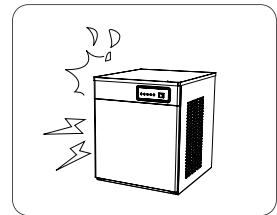

**Stop the operation**  
Do not use flammable gas near the icemaker.

- ◆ It may cause explosion and fire.

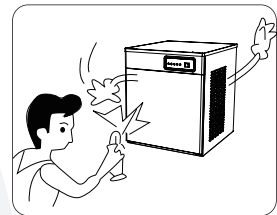

**Stop the operation**  
Replace or tighten the receptacle if it is loose.

- ◆ An electric shock or fire can occur.



## Warning

### Do not disassemble

Do not modify the parts of icemaker, and repair alone by yourself without a qualified technician.

- ◆ It may happen the fire and extra, ordinary operation, and would result in the serious problem.

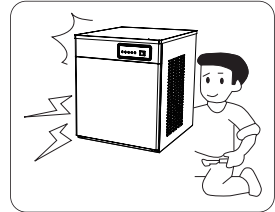

### Prohibition

Do not bend the power cord severely, or allow it to be pressed by a heavy matter, which can cause damage to the cord.

- ◆ There is a danger of a current leak, electric shock and/or fire
- ◆ Be sure to contact the customer service center if the power cord or plug gets peeled.

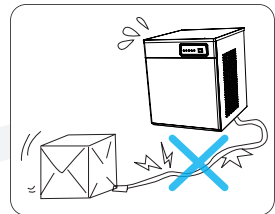

### Prohibition

Do not let children hang on the door of the icemaker.

- ◆ Injury to the child or damage to the icemaker may occur.
- ◆ Avoid hanging onto the front door of the ice maker .

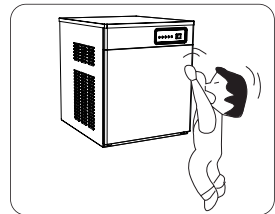

### Do not touch

Do not touch or disconnect the electric power with wet hands.

- ◆ May cause an electric shock.

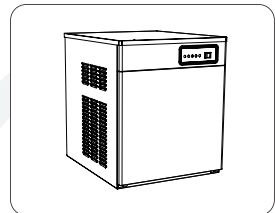

### Do not touch

Do not clean the inside of ice maker by sharp tools.

- ◆ It may cause the damage of colling or electronic system.

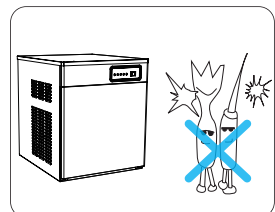



## Warning

### Disconnect electric power

For long term usage interruption or product shut-down, close the water supply valve, remove the ice from the product and disconnect electric power.

### Disconnect electric power

For cleaning or servicing, disconnect electric power, shut off the water feed and wait for the product to come to a complete stop.

- ◆ It may cause electric shock, fire, or injury.

### Disconnect electric power

Separate the power plug from the receptacle with holding the plug body.

- ◆ Pulling the power cord or using a screwdriver to unplug may cause fire or electric sparks.

### Grounded

The Ice Machine must be connected to a grounded power source.

- ◆ An ungrounded circuit may cause product failure or an electric shock.

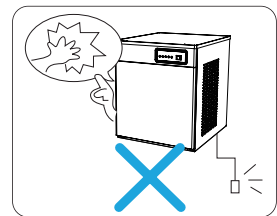

### Installing the product

When installing the product on the container, use an appropriate lifting system or 2~3 men to lift the product.

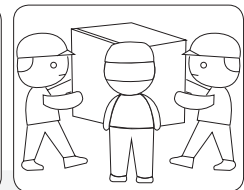

### About the power strip

Make sure the power strip supports power higher than rating volts and 21 A.

- ◆ Using multiple appliances on one power strip may cause fire. Thus, be sure to plug only one appliance especially when using this product.



## Caution

### Caution

Remove any moisture or oil or anything that may cause slipping on the ground near the product.

- ◆ Slipping and hitting the ice maker or sticking one's hand into the bottom will cause injury.

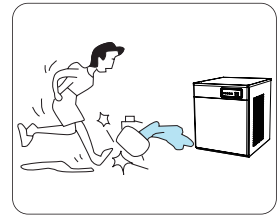

### Hand over

As you turn over the icemaker to the other user, please turn over the operation manual, too.

- ◆ Be sure to refer to the user manual for the safest usage by users who are not familiar with the product.

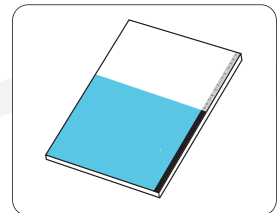

Do not slide the hand or foot in under the icemaker.

- ◆ The bottom of this product has diverse parts including metal sheet, which may cause injury.

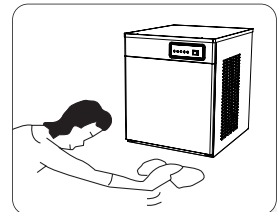

When reconnecting the electric power after disconnection, wait at least 5 minutes before reconnecting.

- ◆ Plugging in right away may cause overload and malfunction.

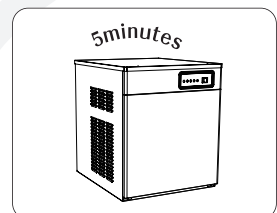

For areas where water contains much calcareous sediments, be sure to install a calcium filter at the water inlet port (calcium may reduce the lifecycle of the product).

## 2. Specifications

Category		IM-0770-AF	IM-0770-AN
		AC 115 V 60 Hz, 1PH	
Ice Shape		FLAKE	NUGGET
※ Maximum Production Capacity at A/W 50°F		794 ± 10%	750 ± 10%
Ice Storage Capacity (Storage bin IB-026-22)		265 lbs	
※ ※ Size (W X D X H) (IB-026-22)		Head : 22" x 25.4" x 26" Head + Storage Bin(Including feet) : 22.4" x 34.3" x 70.4"	
Power Supply		AC 115 V ± 10% 60 Hz	
Min. Circuit Ampacity		20A	
Weight	Before being packaged	185 lbs	
	After being packaged	207 lbs	
Cooling Unit	Output	1 HP	
	Cooling type	Air Cooled Type	
	Refrigerant	R-404A	
Gear Motor	AC Supply Voltage	AC 115 V ± 10% 60 Hz	
	Rated Power (Output)	230 W	
Fuse(PCB)		AC 250 V 5 A	
Conditions for Use	Ambient temperature	50 ~ 100°F	
	Supply water temperature	50 ~ 90°F	
	Water pressure	20 ~ 80 psi	

※ The maximum production calculated is based on ambient temperature and water temperature of 50°F. There may be deviations depending on the installation conditions, which may get severe during high temperature periods such as summer.

※ ※ Be sure to check the specifications before purchasing the product since the dimensions may vary depending on the specifications of the storage bin.



# 3. Part names

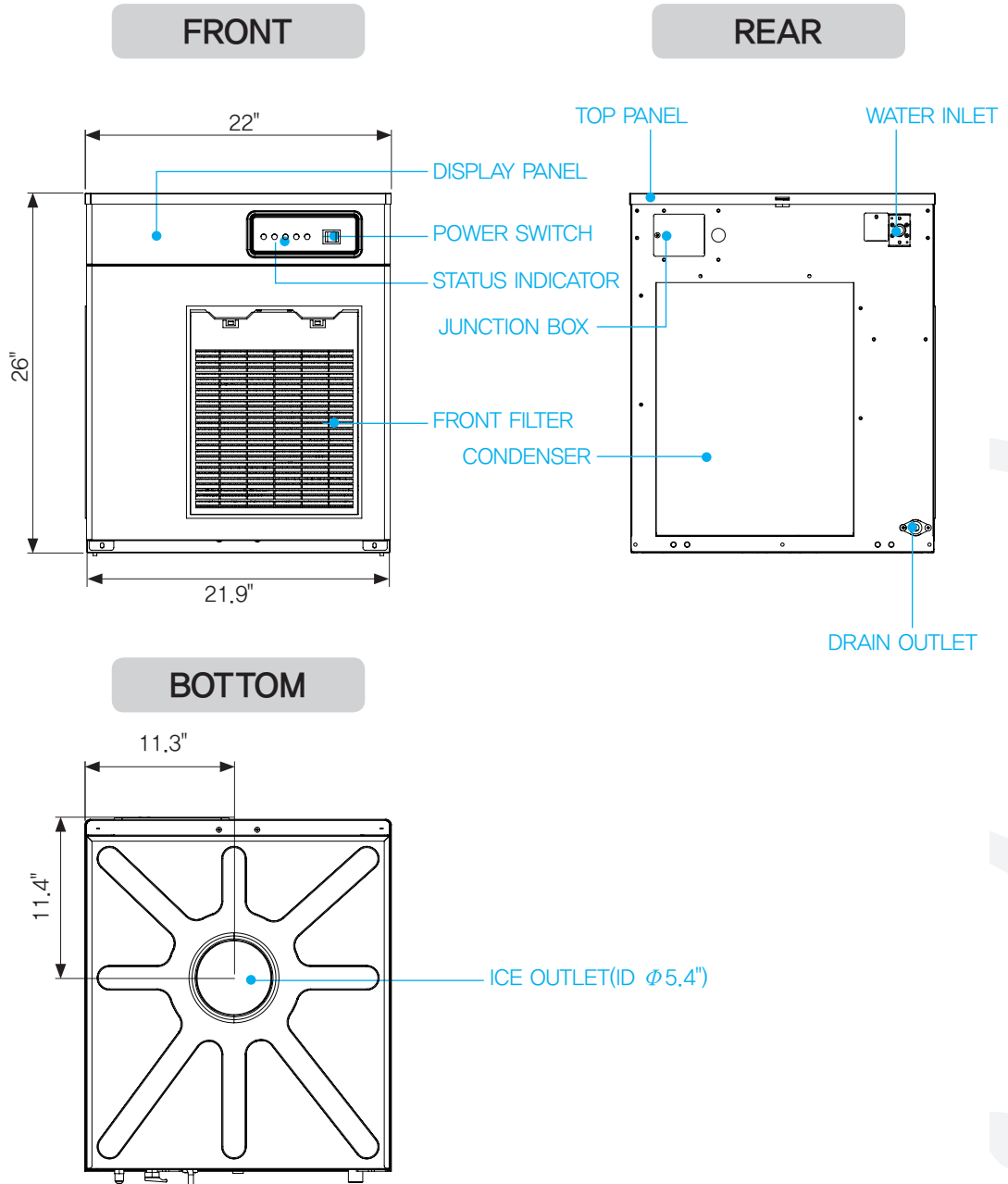

LEFT

RIGHT

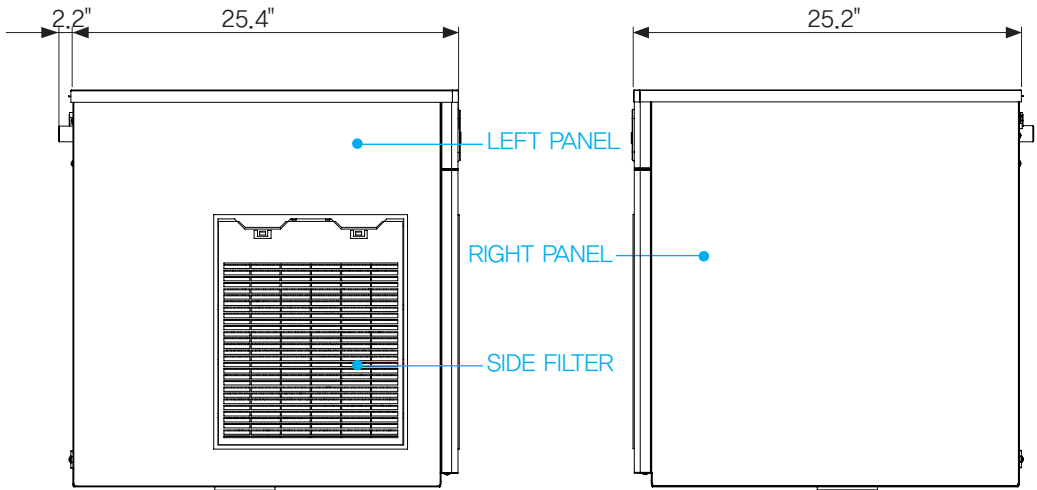

## 4. Installation

### Suitable installation condition and place

● Places without heat source

- ◆ The product has to be installed at places without a heat source such as stove or gas range or any place with ambient temperature of 50~100 °F.

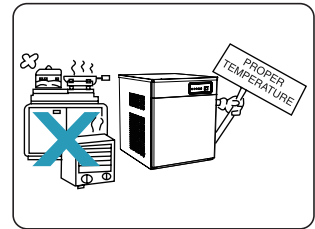

● To the place with enough spaces from the walls

- ◆ The minimum distance required is 8" from the walls for normal operation.
- ◆ Make sure that there is a minimum gap of 17.7" from the top of the product for clearing and maintaining the auger.

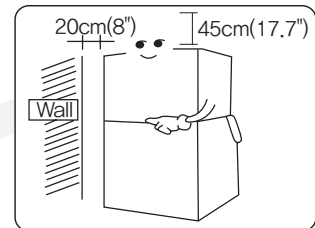

● To the place with good ventilation

- ◆ Poor ventilation will lead to poor ice-making capability.

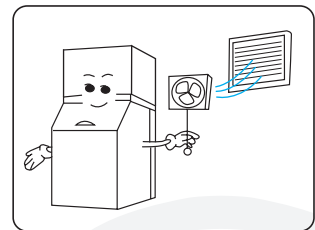

● On even surfaces

- ◆ Uneven surface will result in too much vibration or noise. (The surface angle must be less than 1 °)
- ◆ Installing the product on an uneven surface may cause it to fall or slip and cause injury. Make sure that the product is installed on an even surface.

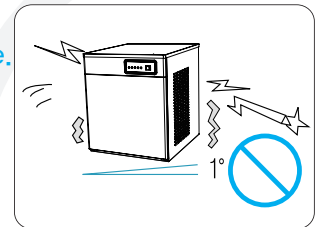

## Suitable installation condition and place

● Be sure to install the product in clean places.

- ◆ Ice will be used for food or human consumption.  
Thus, the installation site must be clean and hygienic.

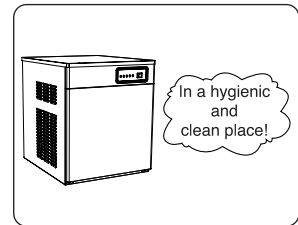

● The product must be installed indoors.

- ◆ The outlet of the drain hose has to face downward to enable smooth draining.
- ◆ The product must not be installed outside.

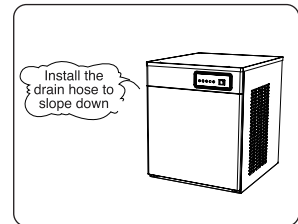

● In a place inaccessible to children.

- ◆ Be sure to apply caution so that children neither get injured nor play with ice.

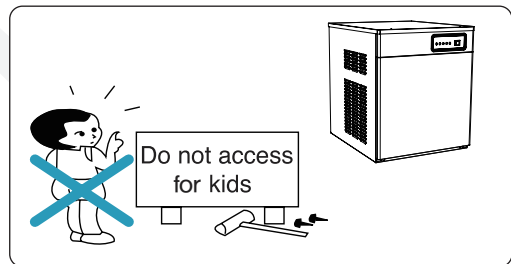

◆ Make sure to observe the following.

- Since the product makes use of water, proper water supply and draining facility are required.
- Water may leak during installation or operation for diverse reasons. Thus, proper draining must be prepared. Since there is danger of electric shock due to moisture from leak, be sure to observe the following:
  1. When installing the product indoors, be sure to have a natural drainage facility and make the floor waterproof, especially if the floor may get damaged due to leak.
  2. A draining outlet must be available at the installation site; be sure to connect the drain hose.
  3. Make sure that the floor is sloped so that any leaked water gets drained away even if the drain hose gets dislodged or damaged. Install a water overflow prevention wall to prevent damage.
- ※ Adjust the height by turning the footing if the floor is sloped to set it stably.
- ※ The manufacturer will not be liable for any problem arising from failure to comply with the warnings above, dislodged / damaged water supply hose, or inappropriate drain facility.



---

---

## How to disassemble the panels

1. Top panel: Unscrew the fixing screws at the front top, lift the panel, and push to the back to remove it.
2. Front panel: Unscrew the fixing screws at the bottom of the front panel and pull both sides to remove the panel.
3. Side panel: Remove the front panel first, unscrew the fixing screws at the front, and pull it to the front and then lift it.

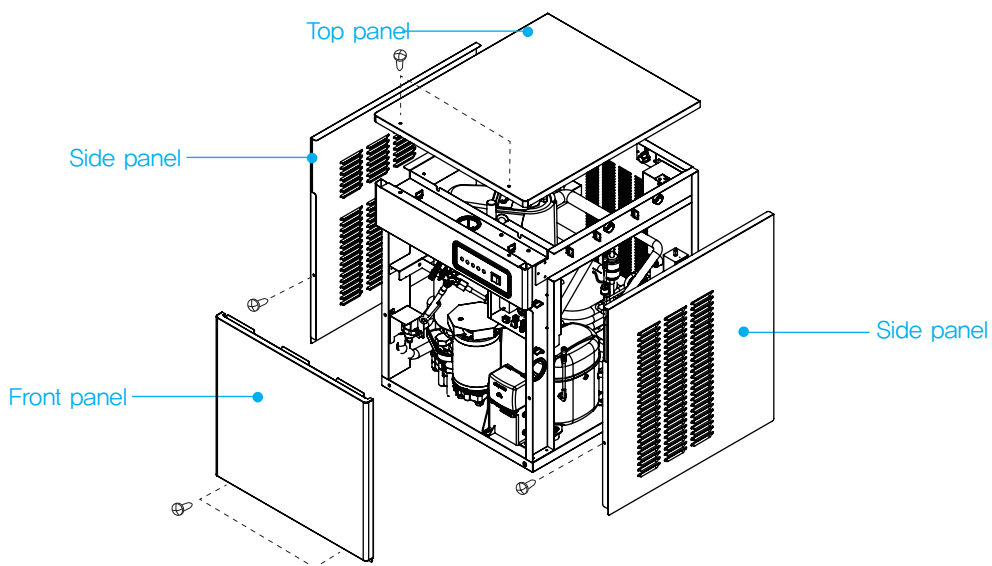

※ Apply the reverse sequence for reassembling the panels.

## How to install the storage bin

1. Unpack the ice storage bin and make sure that it will not be moved after installation.
2. Connect the drain hose at the bottom outlet part and fully tighten the joints at the connecting part in order to minimize leaks.



Tighten the joints at the connecting part, face the outlet of the hose upward, and pour some water into the bin to check for leaks.

3. Adjust the 4 adjustment feet of the storage bin to level it.  
(Adjustment must be less than 1 ° for all 4 feet)

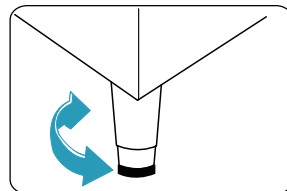

## Installing the ice maker and connecting storage bin

1. Use the lifting device to put the ice maker on top of the bin. Otherwise, at least 2 to 3 persons must work together to put the ice maker on the bin.

◆ Be sure to apply more power to the right part of the ice maker since it is heavier due to the compressor therein.

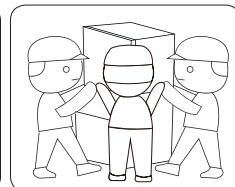

2. As the first phase, put the ice maker on a loading platform.  
(Height of loading platform: Minimum of 39.4" is recommended)

Product  
(Head)

Loading  
platform

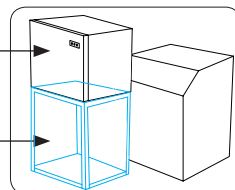

3. As the second phase, move the ice maker from the platform to the top of the bin.

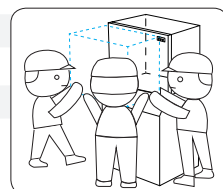

4. Move the ice maker little by little until the front door opens freely.

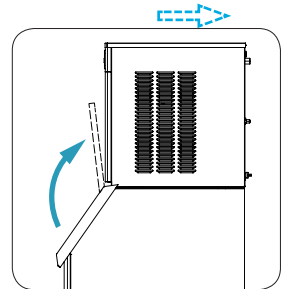

5. Screw the fixing brackets to the back of the ice maker.



The ice maker must be fixed as in the figure below after putting it on top of the bin. The manufacturer shall not be liable for any incident caused by failure to fix the ice maker, such as fall of the maker.

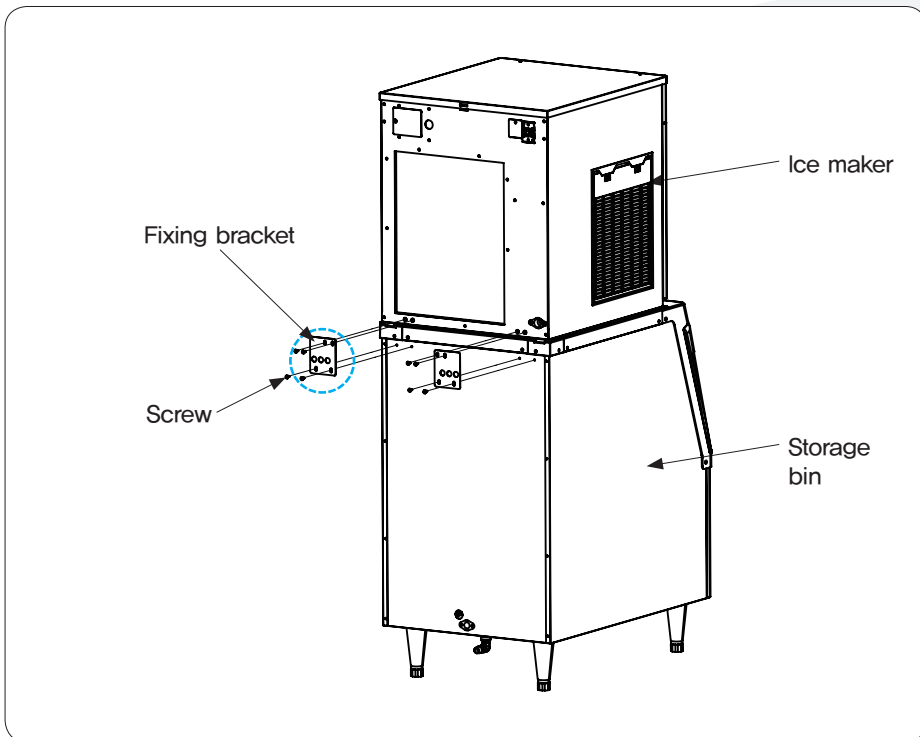

## How to connect water inlet and outlet hoses

### [ Connecting water inlet and outlet hoses to product ]

Category	Appropriate water temperature	Water pressure	Specifications of connecting parts
			AC 115 V / 60 Hz
Water inlet for ice making	50 ~ 90 °F	20 ~ 80 psi	3/8" NPT (M)
Water outlet for ice making	—	—	3/4" NPT (F)

The quantity of ice may decrease if the supplied water is too hot, and ice making may not work properly if the water pressure is too low, which can be supplemented by installing an auxiliary water pressure pump.

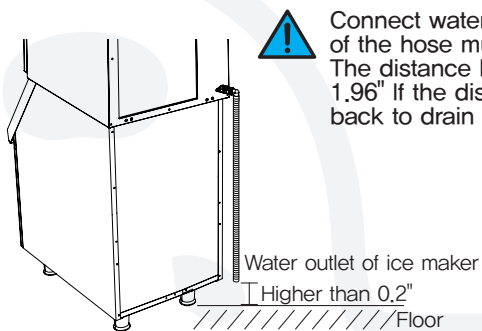
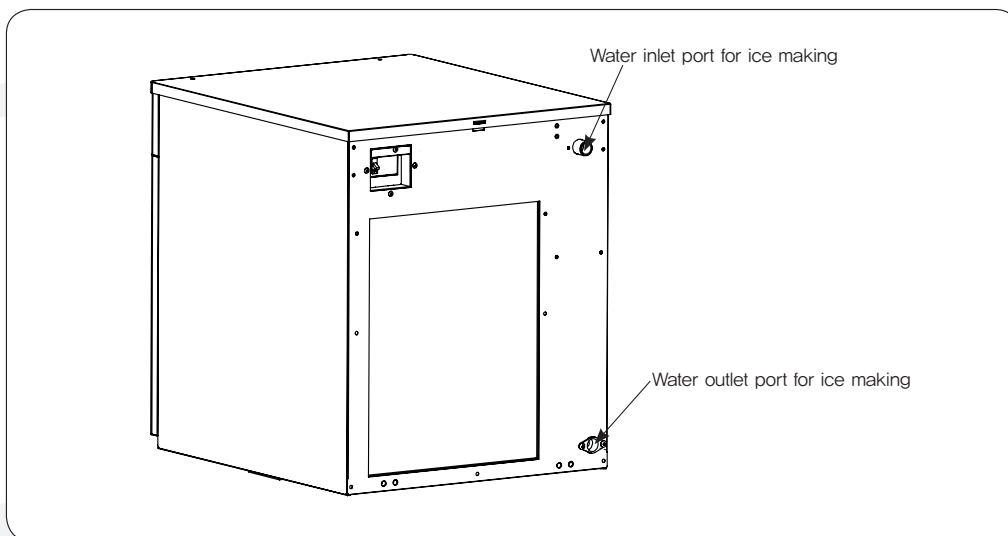

Connect water drain hose to water outlet for which internal diameter of the hose must be more than 0.79".

The distance between end of the hose and floor must be more than 1.96". If the distance is shorter than 1.96", water flow back to drain pan and may cause damage in the ice maker.



## About grounding

※ Be sure to ground the product to prevent electric shock.

⦿ **Grounding method – if there is a grounding terminal**

In case of plugging the icemaker into an rating AC outlet equipped with a grounding terminal, extra grounding is not necessary.

⦿ **Grounding method – if there is no grounding terminal**

In case of plugging the icemaker into an rating AC outlet without a grounding terminal, connect the ground wire to the copper plate and then bury it under the ground.

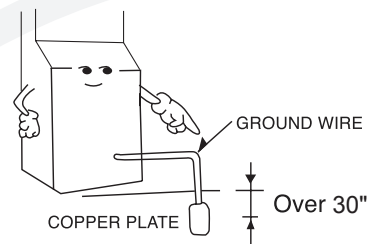

**Do not ground the product on the following:**

Gas piping, water supply, lightning rod, telephone line, or any connection part

※ Plastic water piping or non-insulated material will not provide a grounding effect.

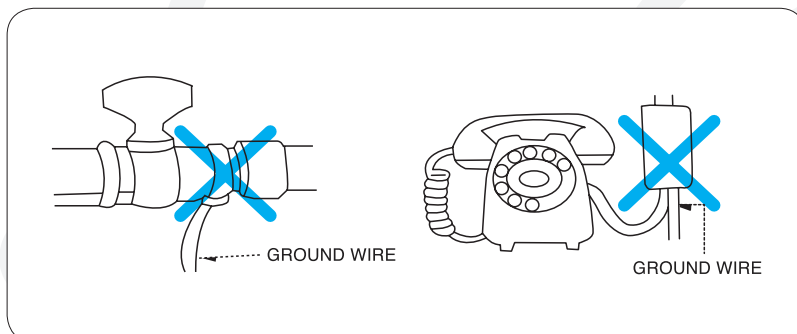

## After installation

- **Protection of the water supply hose**  
Do not put any heavy object on the water supply hose. Do not step on it either.

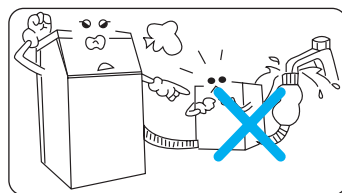

- **The appropriate water pressure, water temperature, or ambient temperature is...**

This ice maker must be used under conditions of 20~80 psi, water supply of 50~90 °F, and ambient temperature of 50~100 °F.



**Connect potable water supply only.**

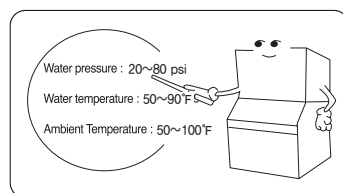

## Electrical Connection

### ⚠ WARNING

- Electrical connection must be hard-wired and must meet national, state, and local electrical code requirements. Failure to meet these code requirements could result in death, electric shock, serious injury, fire, or damage.
- The icemaker requires an independent power supply of proper capacity. See the nameplate for electrical specifications. Failure to use an independent power supply of proper capacity can result in a tripped breaker, blown fuse, damage to existing wiring, or component failure. This could lead to heat generation or fire.
- **THE ICEMAKER MUST BE GROUNDED.** Failure to properly ground the icemaker could result in death or serious injury.
- Electrical connection must be made in accordance with the instructions on the "WARNING" tag.

- Usually an electrical permit and services of a licensed electrician are required.
- The maximum allowable voltage variation is  $\pm 10$  percent of the nameplate rating.
- On single phase models, the green/yellow lead must be connected to the neutral conductor of the power source. **NOTICE! Miswiring may result in damage to the icemaker.**
- The opening for the power supply connection is 1" DIA to fit a 1/2" trade size conduit.

### ⚠ WARNING

#### ELECTRICAL CONNECTION

#### THIS UNIT MUST BE GROUNDED

Failure to properly ground or wire this unit could result in death, serious injury, or severe damage to the ice maker. The green/yellow lead must be connected to the neutral of the power source. See diagram below.

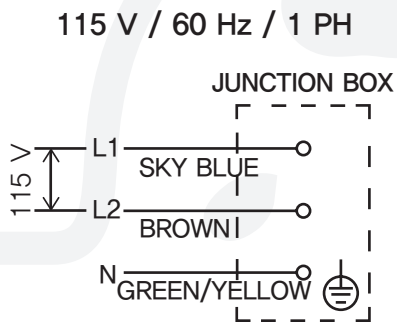

# 5. Starting the product

## Ice making

1. Set the power switch on the front to left('ICE') to start the product.

- ◆ Water is supplied for a moment while the ice making operation is stabilized, and ice making starts after the motor runs for 60 seconds.

- ◆ The time may vary depending on the ambient temperature and water temperature, but it will take about 5 minutes before ice cubes are produced.

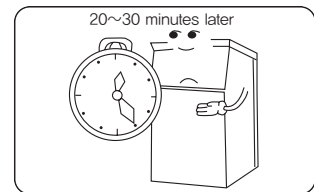
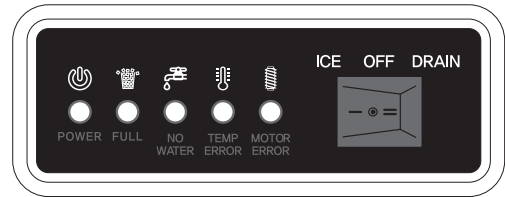

## Water outlet(evaporator)

1. Set the power switch on the front to right ('DRAIN') to start draining.

- ◆ Draining is the operation for clearing the cylinder inside the ice maker or removing any remaining water and ice from the product. Selecting "DRAIN" starts the draining and running of the motor.
- ◆ The ice maker stops after 5 minutes. (Setting the switch at 'OFF' stops the motor after additional 60 seconds of operation.)
- ◆ In order to run the product again, switch back to 'OFF' and select 'ICE' or 'DRAIN' as needed.
- ※ Draining automatically starts every 12 hours while the ice maker is running. During automatic draining, the water inlet, draining, and motor are operated for 20 minutes by repeating starting and stopping.

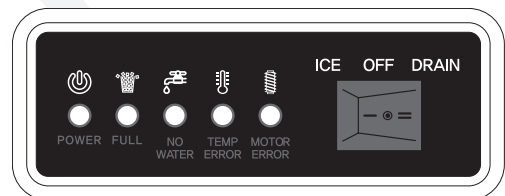

## Stopping the product

1. Set the power switch on the front to center ('OFF') to stop the product.

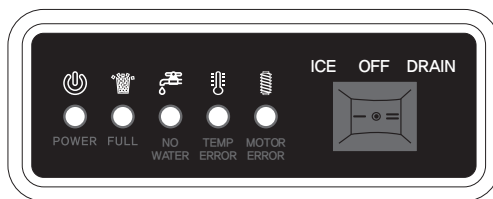

- ◆ While ice making is underway, the operation stops, and the motor is run for an additional 60 seconds. This is for protecting the motor by removing any ice or water from the cylinder.
- ◆ If draining was going on, the product stops after draining is complete. (If "OFF" is selected before 60 seconds after selecting "DRAIN" during ice making, the motor will run for the remaining time before stopping the product.)

## 6. Product Status Indication Lamp Guide

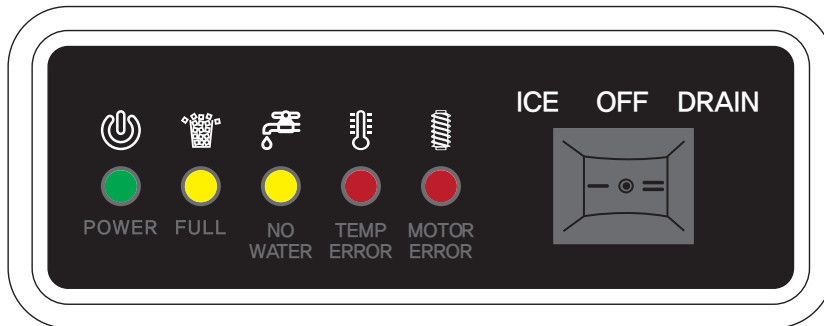

- POWER LAMP(GREEN)**

  - Lamp on when power is on.
  - Blinking(every 2 seconds) : in time of automatic cleaning.
- FULL LAMP(YELLOW)**

  - Lamp on when ice become full.
- NO WATER LAMP(YELLOW)**

  - Lamp on when water supply is short.
- TEMP. ERROR LAMP(RED)**

  - Lamp on when temperature sensor detects unusual conditions.
  - Lamp on : On when condenser temperature is more than 167°F,  
Off when it is below 140°F
  - Lamp blinking(every 1 second) : Evaporator temperature is more than 37.4°F
  - Lamp blinking(every 4 seconds) : Evaporator temperature is low, less than 38.8°F,  
Off when it is more than 50°F
- MOTOR ERROR LAMP(RED)**

  - Lamp on when motor runs lower than certain speed level due to resistance.
- TEMP. AND MOTOR LAMP(RED)**

  - Both lamps blinking(every 2 seconds) : When evaporator outgoing temperature is low(less than -0.4°F)
  - Both lamps on : Refrigerant high pressure sensor is activating.
- POWER FULL NO WATER TEMP MOTOR All lamps blinking**

  - Components are needed to be checked / Notice for exchange (every 1hour) :  
Giving signal for 1 minute (It gives the signal after 10,000 hour to 11,000 hour operation.)



Caution

- When all the 5 lamps blink, it means the components that are needed for regular check-up (please refer to the below) are needed to be changed, so please contact the distributor (the parts will be provided at a cost).
- If not changing the parts, it may cause more cost on repair.

[< Components that are needed for regular check-up or exchange >](#)  
 - The extruding head, the bottom housing, the mechanical seal, the geared motor

## 7. Essential measures to prevent freezing and bursting

Make sure to remove water from the water supply tank and the evaporator



Caution

Water inside the product gets frozen when ambient temperature is lower than 0°C(32°F) and prevents the product from running properly. When the product is not in use for extended periods such as winter, be sure to remove coolant and water completely from the inside of the product as follows: Not removing all coolant and water will cause freezing and bursting, which will critically damage the product. Freezing and bursting are not covered by the warranty, incurring huge repair cost. Make sure to comply with the following.

1. Set the power switch to 'DRAIN' to completely drain water from the ice maker.  
(Up to 5 minutes)

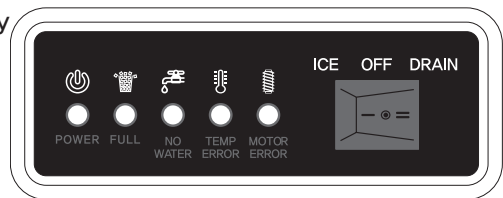

2. Turn off the power and the circuit breaker('OFF') and unplug the power cord from the power outlet.

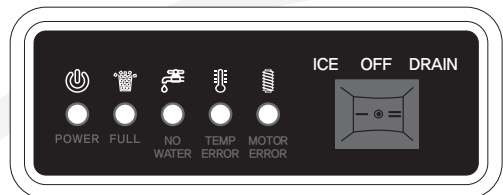

3. Remove the panels in the sequence of top → front → left panels.  
(Refer to 'How to disassemble the panels' on page 13)

4. Remove the water outlet hose clamp of the evaporator cylinder, and then remove the hose and wait until the ice inside the evaporator cylinder completely melts.  
(Compressed air gun may work efficiently in removing water inside.)

5. Reassemble the water outlet hose to the evaporator cylinder and attach the clamp back.

6. Assemble the panels in the sequence of left → top → front panels.

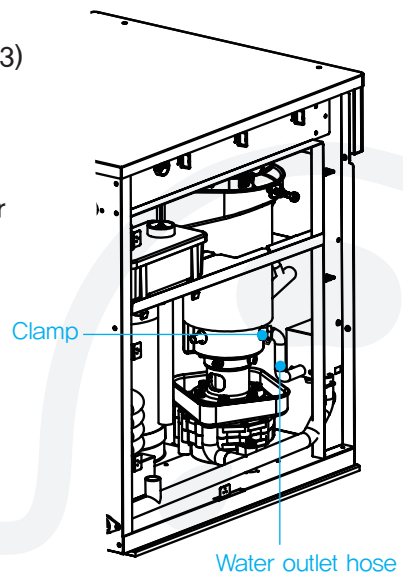

# 8. Maintenance, clearing and sterilizing

※ Make sure that the product is maintained in accordance with the label and the user manual included in the package.



- Make sure that only a qualified technician services the product.
- In order to minimize the risk of electric shocks, do not touch or disassemble the electrical parts of the product.
- Before servicing the product
  - Turn off the power and the circuit breaker('OFF') and unplug the power cord from the power outlet.
- Risk of suffocation
  - After maintenance works, make sure that all parts(fixing parts, screws, bolts) are in place.
  - Make sure that no part falls into the ice maker or the ice storage bin.

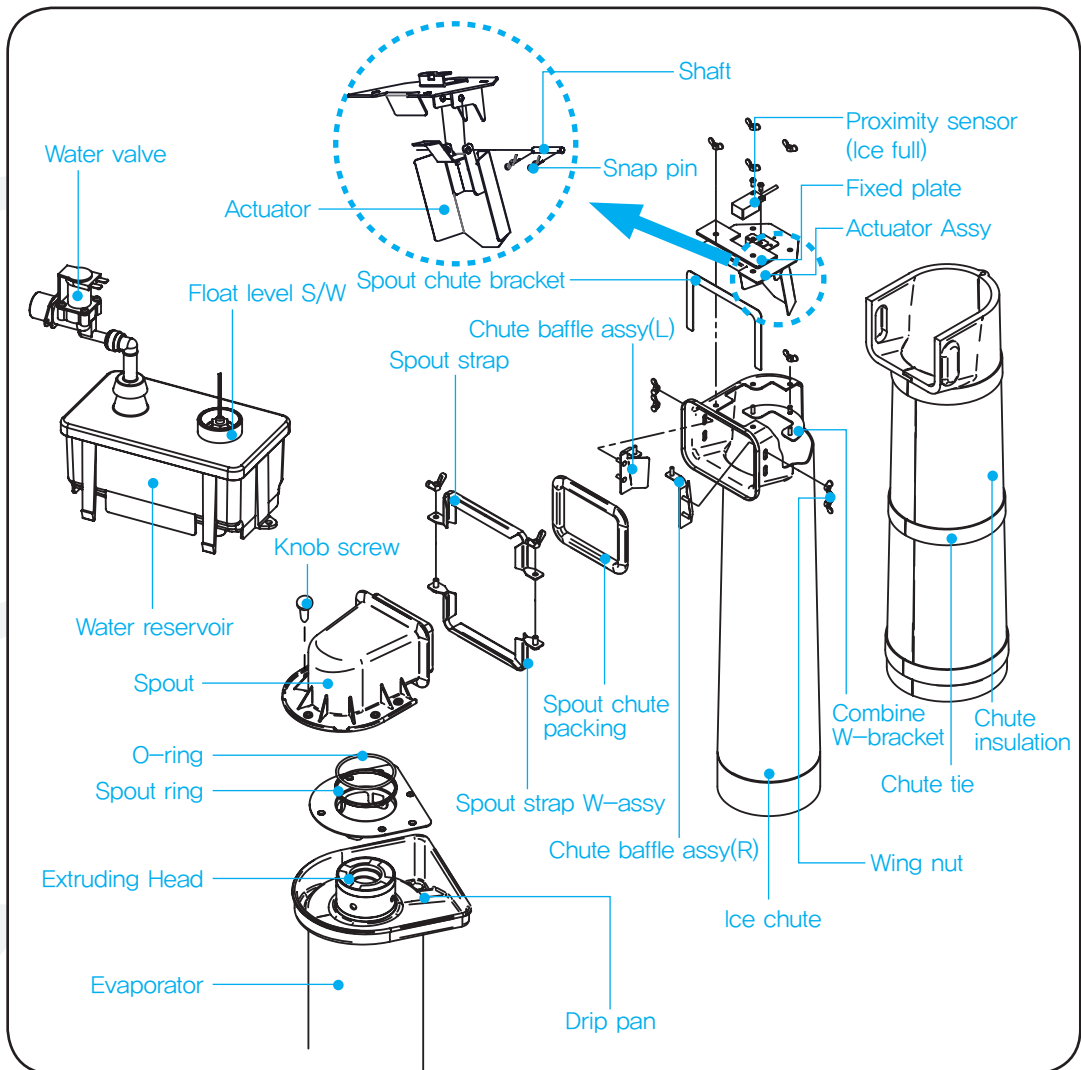



## Maintenance schedule

※ Following maintenance schedule is for reference.

※ More frequent maintenance will be needed in accordance with the local hygiene regulations, water quality, and conditions of the site.

Inspection schedule	Area	Details
Daily	SCOOP	1. Clean the ice scoop with mild detergent. 2. Make sure that the scoop is completely rinsed.
Weekly	Air Filters (Air cooled type)	1. Check for any dust and clean dirty parts with warm water and mild detergent.
Monthly	Outside water filter	1. Check if the pressure is appropriate and adjust as needed.
	Outside of ice maker	1. Clean with clear and soft cloth applied with mild detergent to clear any accumulated dust or oil. 2. Use nonabrasive detergent to clean any part discolored by chlorine(green spots).
	Underneath of ice maker, door of ice bin and entry	1. Clear with clean cloth and warm water.
Every 6 months	Ice maker and ice storage bin	1. Make sure to clean them in accordance with the instruction on the user manual.
	Condensed water outlet fan of evaporator and gear motor drain fan	1. Clear with clean cloth and warm water and pour a cup of sterilizing solution into the condensed water outlet fan of the evaporator according to the sterilizing instructions of the user manual. 2. Make sure that the solution overflows from the drain fan. 3. The solution will flow out through the gear motor drain fan and drain passage. 4. Repeatedly rinse with clean water.
	Ice maker and ice storage bin	1. Frequently check if these are clean.
	Ice outlet fixing seal bolt	1. Check for leakage around the seal bolt. Tighten as needed or replace the O-ring. 2. The O-ring must be replaced each time the seal bolt is loosened and tightened again. Apply Loctite 243 or equivalent fixing material to prevent leakage if no O-ring is available.
Yearly	Water inlet valve and drain valve	1. Close the valve to block the water supply hose and drain water. 2. Clear the port of the water inlet valve and check if the water inlet valve and drain valve leak or operate properly.
	Water hose	1. Check the hoses and clear or replace them as needed.
	Condenser (Air cooled type)	1. Check if cleaning is done properly. Use a brush or a vacuum cleaner as needed. 2. If covered with dust and it got adhesive, please spray fin sanitizer to clean it. Wash it up spraying clean water and dry it using an air gun.
	Ice maker	1. Check for oil spots and any loosened part and examine tightened parts and wires too.
	Top bearing (ice outlet head)	1. Check if there is a gap between the auger and the bearing with a round stick (diameter of 0.02") or a pin; if the gap is wide enough to accommodate it, replace both top and bottom bearings (ice outlet head and bottom housing).
	Mechanical seal	1. Check for leakage inside the bottom housing and if so, disassemble the auger to replace the mechanical seal. (Water with much calcareous sediments shortens lifecycle of replaceable parts.)
Every 3 years	Top and bottom bearings, O-ring of housing, mechanical seal, evaporator cylinder, auger	1. Check them thoroughly. If the gap between the auger and the bearing width is larger than 0.02" as recommended by the manufacturer, replace both top and bottom bearings. Replace the mechanical seal if it is worn or has any crack or scratch.

## Cautions for cleaning the external panel(stainless steel)

### ※ How to remove rust

How to clean rusted parts

#### 1. Rust spots in early stage

- Rust spots in early stage mean that the stainless steel itself is not severely affected, thus mild detergent or any commercially available cleaning agent will restore original state. Rust will be removed with ease and at low cost if regular cleaning is done at appropriate intervals.

#### 2. Red rust

- Rust spots that are not removed after a short period of time will turn into thick reddish–brown rust and will damage the surface of the stainless steel. These are much harder to remove and the surface will not be fully restored; thus, it is important to remove rust spots early on.

If commercially available cleaning agents do not work, use sandpaper or a stainless steel brush to remove the rust before applying the agent for easier removal.

This process requires treatment, such as refurbishment after cleaning.

#### 3. Rust from iron

- Rust from coming into contact with welding spatter, rust from the metal bar above the stainless steel part, or contact between the stainless steel parts and general metal parts are caused galvanic corrosion. This causes the metal to rust first, and it will eventually cause the stainless steel to rust too if it is not removed. As such, make sure to clean and remove rust immediately with a mild detergent. However, when the rust has gotten really bad, it must be removed with 15% nitric acid solution or commercially available stainless steel cleaner.

#### 4. Rust from exhaust gas or acid rain

- In environments, such as a factory complex or heavy transport sites, the product will become contaminated in a short amount of time due to exhaust fumes or acid rain and rust spots will quickly form. Light rust can be washed off with a mild detergent or soapy water, but heavy rust will require 15% nitric acid solution or commercially available stainless steel cleaner.

#### 5. Rust from salt deposit

- In environments, such as windowsills or pipes on the porches of an apartment complex, that are close to the seashore where the product may be directly exposed to the sea winds, STS304 or STS316 will get rusted in no time, and this will occur much faster than in other types of environments. These cases require special treatment, such as using painted stainless steel or regular cleaning.

#### 6. Rusts from disinfectants or cleaning agents

- Sites, such as pools or public baths, that use chlorine–based agents to sterilize the water, especially those for cleaning bathrooms, contain chlorine content that attaches to and rusts the stainless steel surface. Thus, it is important to thoroughly wash off such agents after using them, and a 15% nitric acid solution or commercially available stainless steel cleaner are required for removing this type of rust.

## Cleaning / Sterilizing

※ The ice maker requires cleaning and sterilizing at least twice a year.  
It may need more frequent cleaning and sterilizing.



◆ Make sure to comply with the following.

- Do not use ammonia-based detergent to prevent damage to the personnel or the ice maker itself.
- Cleaning and sterilizing must be conducted in accordance with the instructions on the user manual.
- Always wear protective gloves and goggles to prevent skin or eye from coming into contact with the sterilizing solution.
- Do not use the ice made with the cleaning or sterilizing solution after cleaning and sterilizing.  
Make sure that no sterilizing solution is left on any part of the ice maker and the ice storage bin.

### 1. Cleaning solution

Distill scale remover harmless to human body and increase the ratio as needed.

Distilled cleaning solution must be used immediately to ensure maximum effect and safety.

### 2. Cleaning procedure

- 1) Close the water valve to stop water supply.
- 2) Set the front power switch to 'DRAIN'.
- 3) Water in the water tank is drained through the evaporator cylinder and cleans it for up to 5 minutes.
- 4) Set the front power switch to 'OFF' and the switch of the circuit breaker on the back to 'OFF' as well.
- 5) Remove all ice from the ice maker and storage bin.
- 6) Unscrew 5 knob screws from the ice chute assembly and lift up to remove it.
- 7) Pour the cleaning solution to the extruding head until the evaporator and water reservoir are full.  
(Up to the point that the solution overflows from the drip pan)  
※ If too much scale at the extruding head clogs the hose between the water reservoir and the evaporator, fill with cleaning solution until the water reservoir is full and until the extruding head at the top of the evaporator is fully immersed.
- 8) Insert the chute baffle assy(l/r) of the ice chute assembly to the inlet of the evaporator and fix it securely with 4 wing nuts.
- 9) Leave the ice maker for about 10 minutes before operating the product, and if the water reservoir hose is clogged in Step 7, make sure to unclog it before starting operation.
- 10) As with the following description, clean contaminated float level s/w(high, low) by disassembling the water reservoir. Otherwise, move on to Step 11.
  - Ⓐ Remove the float level s/w from the cover of water reservoir.
  - Ⓑ Clean the sensor with the cleaning solution.
  - Ⓒ Completely rinse the sensor with clean water.
  - Ⓓ Reassemble the sensor back in place.
- 11) Turn on the circuit breaker and set the power switch to 'ICE' to operate the ice maker.  
Operate it until ice making stops(※ Water will not be supplied as water supply hoses are closed).
- 12) Set the power switch to 'DRAIN' and drain remaining solution from the water supply and evaporator cylinder for 5 minutes.
- 13) Set the front power switch to 'OFF'.
- 14) Open the valve that locked the water supply hoses and set the power switch to 'ICE' so that water may be supplied.
- 15) When the gear motor starts running, set the power switch to 'DRAIN' to drain water for about 5 minutes.
- 16) Turn off the power switch and circuit breaker and unplug the power cord.

### 3. Cleaning and sterilizing

Distill 400ml(13,5 fl.oz) of 5,25% sodium hypochlorite solution(for whitening) with 10L(338 fl.oz) of warm water.

(Refer to the user manual of the solution as the ratio may vary per manufacturer).

This is the minimum ratio – increase the ratio of the solution as needed.

- ※ Distilled cleaning solution must be used immediately to ensure maximum effect and safety.
- ※ ice machine cleaner & sanitizer has to comply with 40 CFR § 180.9403 or registered with the USEPA Office of Pesticides Program, Antimicrobials Division as a food contact ice machine cleaner & sanitizer.

### 4. Sterilizing procedure – Early steps

- 1) Block water supply by closing the water valve, turn off the power switch and circuit breaker and check if the power cord is unplugged and disassemble the top and front panels.
- 2) Unscrew 5 knob screws from the ice chute assembly and lift up to remove it and remove the O-ring and spout ring.
- 3) Pour the sterilizing solution to the extruding head until the extruding head and water reservoir are full, (Up to the point that the solution overflows from the drip pan)
- 4) Remove the proximity switch from the storage tank controlling assembly.
- 5) Remove 2 wing nuts from the spout strap and spout strap w-assy to disassemble all parts. Remove the chute insulation from the bottom of ice chute(3 chute ties and chute insulation).
- 6) Remove 6 wing nuts and disassemble chute baffle assy(l/r) and plastic fixed plate.
- 7) Remove 2 wing nuts from the top of the ice chute, and then lift the actuator assy while removing the combine w-bracket by unscrewing 1 wing nut from the back.
- 8) Remove 2 snap pins from actuator assy and disassemble the shaft and actuator.
- 9) Clean and sterilize spout, O-ring, spout ring, spout chute packing, spout strap, strap w-assy, spout chute bracket, ice chute, chute baffle assy(l/r), plastic fixed plate, actuator assy and combine w-bracket for 10 minutes.
- 10) Completely rinse all parts with clean water (※ Any remaining cleaning solution will cause corrosion).
- 11) Make sure that all parts are assembled in correct places.  
(※ Chute baffle assy(l/r) must be assembled so that ice cubes will be led to the inside(front of the actuator).
- 12) Plug the power cord to the outlet, turn on the circuit breaker and set the power switch to 'ICE' until sterilizing solution is drained and ice making stops.
- 13) Set the power switch to 'DRAIN' to drain water for 5 minutes.
- 14) Turn off the power switch and circuit breaker and unplug the power cord.

### 5. Sterilizing procedure – Last steps

- 1) Make a new batch of sterilizing solution in a new container.
- 2) Block water supply by closing the water valve, turn off the power switch and circuit breaker and check if the power cord is unplugged and disassemble the top and front panels.
- 3) Unscrew 5 knob screws from spout and lift up to remove it.
- 4) Pour the sterilizing solution to the extruding head until the extruding head and water reservoir are full, (Up to the point that the solution overflows from the drip pan)
- 5) Insert the spout of ice chute assembly at the correct location and screw 5 knob screws to fix the assembly.
- 6) Leave the ice maker for 10 minutes before operating it.
- 7) Plug the power cord to the outlet, turn on the circuit breaker and set the power switch to 'ICE' until sterilizing solution is drained and ice making stops.
- 8) Set the power switch to 'DRAIN' to drain water for 5 minutes.
- 9) Set the power switch to 'ICE' and open the water supply valve to fill the tank with water.
- 10) Set the power switch to 'OFF' when the gear motor starts running.
- 11) Set the power switch to 'DRAIN' to drain water for 5 minutes.
- 12) Set the power switch to 'ICE' and make ice cubes for 30 minutes then set the switch back to 'OFF'.
- 13) Pour warm water into the ice tank to melt the cubes and drain water, then clean the tank with mild detergent. Make sure to rinse the tank with clean water.

## 9. Error type

Type	Cause	Indicator lamp	Measures	Disabling indication	Operation
Filled	Storage bin is filled with ice cubes.	'FULL' indicator lights up	Use ice cubes	Automatically disabled when the storage bin has some room.	Stops
Water supply error	Water for ice making is not supplied on time.	'NO WATER' indicator lights up	Check water supply	Power back on when water is supplied	Stops
Evaporator temperature error	Evaporator is not cooled down properly.	'TEMP' indicator flashes each second	Check cooling part (Contact manufacturer)	Power back on when cooling issue is resolved.	Stops
	Evaporator inlet is overcooled.	'TEMP' and 'MOTOR' indicators flash every 2 seconds simultaneously	Unplug and plug back power cord in 1 hour (Contact manufacturer if error persists)	Power back on when cooling issue is resolved.	Stops
Low temperature error of condenser	Ambient temperature is too low (Lower than 33.8°F)	'TEMP' indicator flashes every 4 seconds	Operate with ambient temperature above 50°F	Automatically disabled when ambient temperature goes above 50°F.	Stops
High temperature error of condenser	Ambient temperature is too high or condenser fails to cool (higher than 167°F)	'TEMP' indicator lights up	Check coolant supply lines	Automatically disabled when ambient temperature goes above 140°F.	Stops
Motor lock error	Motor is locked by foreign objects inside the product.	'MOTOR' indicator lights up	Unplug and plug back power cord in 1 hour (Contact manufacturer if error persists)	Power back on when the issue is resolved.	Stops
Evaporator sensor error	Evaporator temperature sensor malfunctions	'TEMP' indicator lights up and 'MOTOR' indicator flashes	Replace the sensor (Contact manufacturer)	Power back on after replacing the sensor	Stops
Condenser sensor error	Condenser temperature sensor malfunctions	'TEMP' indicator flashes and 'MOTOR' indicator lights up	Replace the sensor (Contact manufacturer)	Power back on after replacing the sensor	Stops
High pressure error	Condenser fails to cool	'TEMP' and 'MOTOR' indicators light up simultaneously	Check coolant supply lines (Contact manufacturer if error persists)	Power back on after solving coolant supply issue	Stops

# 10. Before contacting the manufacturer

Make sure to check the following if the product is operated inappropriately. If the issue persists, contact the local distributor where you purchased the product or the customer service center.

Please provide the information on the warranty when you contact us.

(Model, serial number, name of distributor, date of purchase and detailed description of issue)

Operational status	What to check	Measures
1. Ice maker does not work	1. Is power supplied?	Turn on the main switch.
	2. Is circuit breaker ON?	Turn on the circuit breaker.
	3. Is the power supply of the machine using rating volts?	Check the power and make sure to use the proprietary plug.
	4. Is the power switch on the front turned on?	Make sure to set the front power switch at 'ICE'.
2. Water is not supplied.	1. Is water valve closed?	Open the water valve.
	2. Is water inlet hose installed properly?	Check and take necessary measures.
	3. Is water working?	Check the water source.
	4. Is water valve working?	Check and contact the customer service center.
3. Takes too long to make ice cubes.	1. Ice maker is too dirty(too much dust). (Air cooled type)	Disassemble the front cover, remove the dust filter and clean it with a vacuum cleaner. Too much dust deteriorates performance and may make the product use too much power.
	2. Is ambient temperature not too high or low?	Operational temperature is 50~100°F. Make sure that ambient temperature is appropriate.
	3. Is the water inlet valve too clogged or has too much dreg?	Disassemble the valve and remove foreign objects from the filter. Make sure that the tap is closed for this.
4. Ice maker is too noisy or makes strange noises.	1. Is the floor level or solid enough?	Make sure that the floor is fully even.
	2. Does either front or back of the ice maker come into contact with the wall?	There must be a gap wider than 19.7" from the walls.
	3. Is supplied water too cold?	Water temperature needs to be 50~60°F.
	4. Does the ice making device make too much noise?	Set the power switch to 'OFF', melt all ice and set the switch back to 'ICE'. Contact the customer service center.

# MEMO

---



Online Internet Service  
<http://www.icetro.com>

